



Pro Cinema LS12000 User's Guide

Contents

Pro Cinema LS12000 User's Guide	9
Introduction to Your Projector	10
Projector Features.....	10
Product Box Contents.....	11
Additional Components	12
Optional Equipment and Replacement Parts.....	12
Warranty and Registration Information (U.S. and Canada)	13
Warranty and Registration Information (Latin America).....	13
Notations Used in the Documentation	13
Where to Go for Additional Information	14
Projector Part Locations	14
Projector Parts - Front/Top	15
Projector Parts - Rear	16
Projector Parts - Base.....	18
Projector Parts - Remote Control.....	19
Setting Up the Projector	21
Projector Placement.....	21
Projector Setup and Installation Options	21
Projection Distance.....	23
Projector Connections	27
Connecting to an HDMI Video Source	28
Connecting to a Computer for HDMI Video.....	28
Connecting to a Streaming Media Player	29
Connecting External Output Devices.....	30
Connecting an A/V System or External Speakers Using HDMI ARC	30
Connecting to a Trigger Out Port	31
Attaching and Removing the Cable Cover.....	32
Installing Batteries in the Remote Control	34
Monitoring and Controlling the Projector	37
Connecting to a Wired Network.....	37

Selecting Wired Network Settings	37
Projector Control Settings.....	39
Using Basic Projector Features	41
Turning On the Projector	41
Turning Off the Projector	43
Selecting the Language for the Projector Menus.....	44
Adjusting the Image Height	45
Adjusting the Image Position Using Lens Shift	46
Image Shape.....	48
Correcting Image Shape with H/V-Keystone	48
Correcting Image Shape with Quick Corner	51
Correcting Image Shape with Point Correction.....	54
Resizing the Image with the Zoom Feature	56
Focusing the Image with the Lens Button.....	57
Remote Control Operation	58
Selecting an Image Source	58
Projection Modes	59
Changing the Projection Mode Using the Menus.....	60
Image Aspect Ratio	61
Changing the Image Aspect Ratio.....	61
Available Image Aspect Ratios	62
Color Mode.....	62
Changing the Color Mode.....	63
Available Color Modes.....	63
Adjusting Image Sharpness	64
Adjusting the Projector's Brightness Level	65
Turning On Dynamic Contrast.....	66
Adjusting the Color Temperature.....	66
Adjusting the RGB Offset and Gain	68
Adjusting Gamma.....	69
Adjusting the Hue, Saturation, and Brightness	72
Adjusting Projector Features	74
Operating Connected Devices Using the HDMI Link Features.....	74

Shutting Off the Picture Temporarily	76
Projector Security Features	76
Locking the Projector's Lens Settings and Buttons	77
Unlocking the Projector's Buttons	78
Installing a Security Cable	78
Using Advanced Image Adjustment Features	79
Using Frame Interpolation	79
Creating Image Presets	81
Adjusting the Color Convergence (Panel Alignment).....	83
Adjusting the Color Tone (Color Uniformity)	87
Saving Settings to Memory and Using Saved Settings	90
Copying Menu Settings Between Projectors	92
Saving Settings to a USB Flash Drive.....	92
Transferring Settings from a USB Flash Drive	93
Saving Settings to a Computer	94
Transferring Settings from a Computer	95
Adjusting the Menu Settings	97
Using the Projector's Menus.....	97
Image Quality Settings - Image Menu	99
Input Signal Settings - Signal I/O Menu	104
Installation Settings - Installation Menu	108
Display Settings - Display Menu.....	110
Feature Settings - Operation Menu	112
Administration Settings - Management Menu.....	114
Network Settings - Network Menu	117
Image Quality Memory Settings - Memory Menu	119
Initial Settings and Reset Options - Initial/All Settings Menu	120
Maintaining and Transporting the Projector	122
Projector Maintenance	122
Cleaning the Lens.....	122
Cleaning the Projector Case.....	123
Air Filter and Vent Maintenance	123
Cleaning the Air Filter.....	124

Replacing the Air Filter	128
Replacing the Remote Control Batteries	130
Updating the Firmware	132
Updating Projector Firmware Using a USB Storage Device	132
Updating Projector Firmware Using a Computer and USB Cable	133
Transporting the Projector	134
Solving Problems	135
Projection Problem Tips	135
Projector Light Status	136
Solving Image or Sound Problems	138
Solutions When No Image Appears	139
Solutions When "No Signal" Message Appears	140
Displaying From a PC Laptop	140
Displaying From a Mac Laptop	141
Solutions When Only a Partial Image Appears	141
Solutions When the Image is Not Rectangular	142
Solutions When the Image Contains Noise or Static	142
Solutions When the Image is Fuzzy or Blurry	143
Solutions When the Image Brightness or Colors are Incorrect	144
Solutions to Image and Sound Syncing Problems	145
Solutions to Sound Problems	145
Solving Projector or Remote Control Operation Problems	145
Solutions to Projector Power or Shut-Off Problems	146
Solutions to Remote Control Problems	146
Solutions to HDMI Link Problems	147
Where to Get Help (U.S. and Canada)	148
Where to Get Help (Latin America)	149
Technical Specifications	151
General Projector Specifications	151
Projector Light Source Specifications	153
Remote Control Specifications	153
Projector Dimension Specifications	153
Projector Electrical Specifications	156

Projector Environmental Specifications.....	156
Projector Safety and Approvals Specifications.....	157
Supported Video Display Formats.....	157
Notices	158
Recycling (U.S. and Canada).....	158
Important Safety Information	158
Laser Safety Information	158
Important Safety Instructions.....	161
Restriction of Use	164
List of Safety Symbols (corresponding to IEC60950-1 A2).....	164
FCC Compliance Statement.....	169
Binding Arbitration and Class Waiver	170
Trademarks	173
Copyright Notice.....	173
A Note Concerning Responsible Use of Copyrighted Materials.....	174
Copyright Attribution	174

Pro Cinema LS12000 User's Guide

Welcome to the Pro Cinema LS12000 *User's Guide*.

For a printable PDF copy of this guide, [click here](#).

Introduction to Your Projector

Refer to these sections to learn more about your projector and this manual.

[Projector Features](#)

[Notations Used in the Documentation](#)

[Where to Go for Additional Information](#)

[Projector Part Locations](#)

Projector Features

Your projector includes these special features:

Bright, high-resolution projection system

- Laser light source with up to 2700 lumens of color brightness (color light output) and 2700 lumens of white brightness (white light output)

Note: Color brightness (color light output) and white brightness (white light output) will vary depending on usage conditions. Color light output measured in accordance with IDMS 15.4; white light output measured in accordance with ISO 21118.

- Full HD native resolution with 4K Enhancement for exceptional brightness, color, and detail
- Scene Adaptive Gamma, Image Enhancement, and Frame Interpolation features
- Images up to 300 inches (7.62 m) for projection on any wall or screen

Flexible connectivity

- Two HDMI ports for video device or computer connections
- HDMI 2.1 support for full audio and video signal bandwidth and Enhanced Audio Return Channel (eARC) for uncompressed audio
- Support for an optical HDMI connection

Easy-to-use setup and operation features

- Powered vertical and horizontal lens shift
- Powered 2.1× optical zoom ratio for improved zooming capability
- Powered focus adjustments

[Product Box Contents](#)

[Additional Components](#)

[Optional Equipment and Replacement Parts](#)

[Warranty and Registration Information \(U.S. and Canada\)](#)

[Warranty and Registration Information \(Latin America\)](#)

Parent topic: [Introduction to Your Projector](#)

Product Box Contents

Save all the packaging in case you need to ship the projector. Always use the original packaging (or equivalent) when shipping.

Make sure your product box included all of these parts:

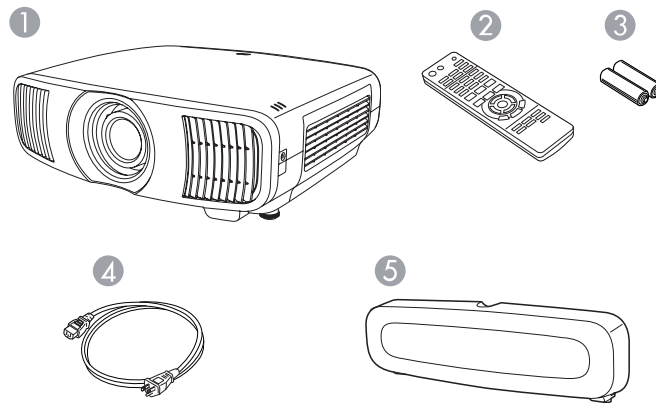

- 1 Projector
- 2 Remote control
- 3 Remote control batteries (two AA alkaline)
- 4 Power cord
- 5 Cable cover

Your product box also includes a projector mount kit (not pictured).

Parent topic: [Projector Features](#)

Related tasks

[Attaching and Removing the Cable Cover](#)

Additional Components

Depending on how you plan to use the projector, you may need to obtain additional components.

Note: To connect a Mac that does not include a compatible video output port, you need to obtain an adapter that allows you to connect to an input port on the projector. Contact Apple for compatible adapter options. To connect a smartphone or tablet, you may need to obtain an adapter that allows you to connect to the projector. This allows you to mirror your smartphone or tablet screens, watch movies, and more. Contact your device manufacturer for compatible adapter options.

Unless listed as available from Epson in this table, see your local computer or electronics dealer for purchase information.

Signal or connection type	Additional component necessary
HDMI	Compatible HDMI cable or HDMI 2.1 certified cable (ultra high-speed) Available for purchase from Epson or an authorized Epson reseller.
Optical HDMI	Compatible optical HDMI cable
External audio	Speakers, an audio video receiver, or a video source with speaker connections, and the cables necessary for connecting them Your projector does not have an internal speaker or audio out ports.

Parent topic: [Projector Features](#)

Optional Equipment and Replacement Parts

U.S. and Canada: You can purchase screens, other optional accessories, and replacement parts from an Epson authorized reseller. To find the nearest reseller, call 800-GO-EPSON (800-463-7766) in the U.S. or 800-807-7766 in Canada. Or you can purchase online at epsonstore.com (U.S. sales) or epsonstore.ca (Canadian sales).

Latin America: You can purchase optional accessories and replacement parts from an Epson authorized reseller. To find the nearest reseller, go to latin.epson.com. Or you can contact your nearest sales office as described in "Where to Get Help."

Note: Availability of accessories varies by country.

Epson offers the following optional accessories and replacement parts for your projector:

Option or part	Part number
Replacement air filter (ELPAF62)	V13H134AB0

Parent topic: [Projector Features](#)

Related references

[Where to Get Help \(U.S. and Canada\)](#)

[Where to Get Help \(Latin America\)](#)

Warranty and Registration Information (U.S. and Canada)

Your projector comes with a basic warranty that lets you project with confidence. For details, see the warranty brochure that came with your projector.

Note: Availability varies by region.

Register your product online at this site: epson.com/webreg

Registering also lets you receive special updates on new accessories, products, and services.

Parent topic: [Projector Features](#)

Warranty and Registration Information (Latin America)

Your projector comes with a basic warranty that lets you project with confidence. For details, see the warranty that came with your projector.

Register your product online at latin.epson.com/support, search for your product, and select **Register**.

Registering also lets you receive special updates on new accessories, products, and services.

Parent topic: [Projector Features](#)

Notations Used in the Documentation

Follow the guidelines in these notations as you read your documentation:

- **Warnings** must be followed carefully to avoid bodily injury.
- **Cautions** must be observed to avoid damage to your equipment.
- **Notes** contain important information about your projector.

- **Tips** contain additional projection information.

Parent topic: [Introduction to Your Projector](#)

Where to Go for Additional Information

Need quick help on using your projector? Here's where to look for help:

- epson.com/support (U.S.), epson.ca/support (Canada), or latin.epson.com/support (Caribbean)

View FAQs (frequently asked questions) and e-mail your questions to Epson technical support 24 hours a day.

- If you still need help after checking this manual and any other sources listed here, you can use the Epson PrivateLine Support service to get help fast (U.S. and Canada only). For details, see "Where to Get Help."

Parent topic: [Introduction to Your Projector](#)

Related references

[Where to Get Help \(U.S. and Canada\)](#)

[Where to Get Help \(Latin America\)](#)

Projector Part Locations

Check the projector part illustrations to learn about the parts on your projector.

[Projector Parts - Front/Top](#)

[Projector Parts - Rear](#)

[Projector Parts - Base](#)

[Projector Parts - Remote Control](#)

Parent topic: [Introduction to Your Projector](#)

Projector Parts - Front/Top

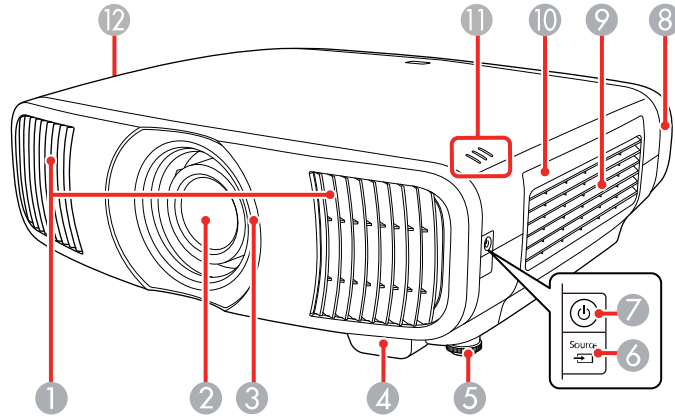

- 1 Air exhaust vent
- 2 Lens
- 3 Lens shutter
- 4 Remote receiver
- 5 Front adjustable foot
- 6 **Source** button
- 7 Power button/light
- 8 Cable cover
- 9 Air intake vent
- 10 Air filter cover
- 11 Indicator lights
- 12 Air intake vent

Parent topic: [Projector Part Locations](#)

Projector Parts - Rear

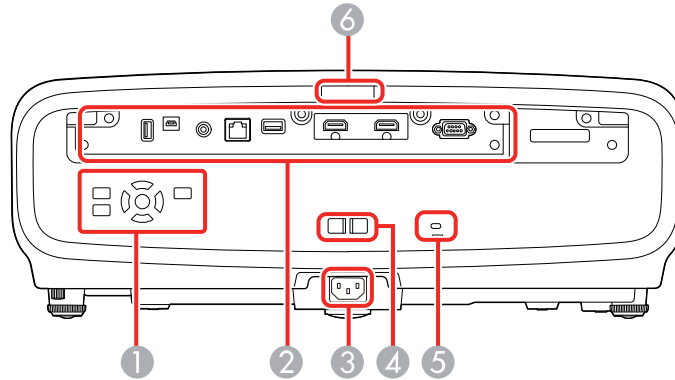

- 1 Control panel
- 2 Interface ports
- 3 AC power inlet
- 4 Cable holder slot
- 5 Kensington security slot
- 6 Remote receiver

Interface ports

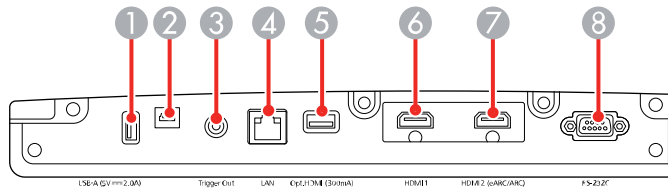

- 1 **USB-A (5V---2.0A)** port
- 2 **Service** port
- 3 **Trigger Out** port

- 4 **LAN** port
- 5 **Opt.HDMI (300mA)** port (supports power connection for optical HDMI cables)
- 6 **HDMI1** port (supports HDCP 2.3)
- 7 **HDMI2** port (supports HDCP 2.3 and HDMI eARC/ARC)
- 8 **RS-232C** port

Control panel

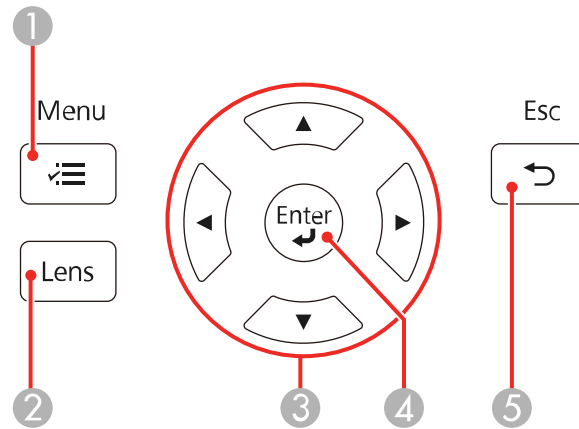

- 1 **Menu** button (accesses projector menu system)
- 2 **Lens** button (cycles through lens adjustment options)
- 3 Arrow buttons (navigates on-screen options, displays previously used **Geometry Correction** screen)
- 4 **Enter** button (selects options)
- 5 **Esc** button (cancels/exits functions)

Parent topic: [Projector Part Locations](#)

Related concepts

[Projector Connections](#)

Related tasks

[Installing a Security Cable](#)

Projector Parts - Base

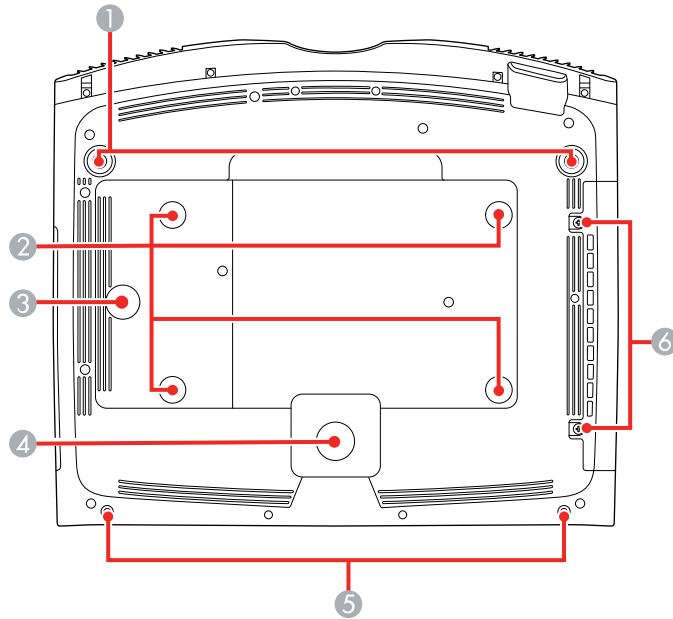

- 1 Front adjustable feet
- 2 Ceiling mount bracket holes (4)
- 3 Safety wire clamp fixing point
- 4 Rear foot
- 5 Cable cover screw holes
- 6 Air filter cover screws

Note: Use M4×10mm screws for mounting the projector.

Parent topic: [Projector Part Locations](#)

Related references

[Projector Dimension Specifications](#)

Projector Parts - Remote Control

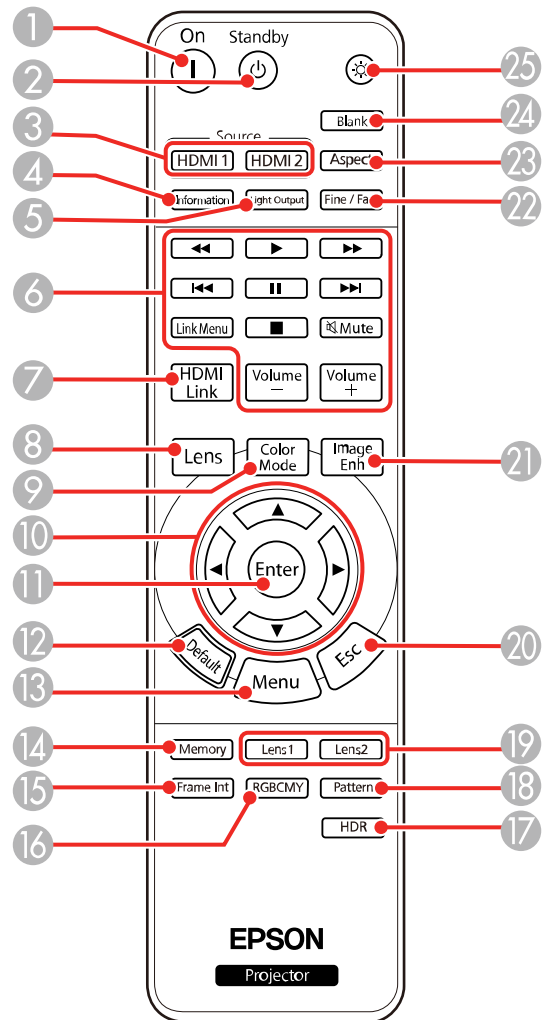

1 On button (turns on projector)

- 2 **Standby** button (turns off the projector)
- 3 **Source** buttons (selects HDMI input sources)
- 4 **Information** button (displays the Information screen)
- 5 **Light Output** button (displays the Light Output menu)
- 6 **Link Menu** button (displays the main menu of the connected device)
Control buttons (control playback and other features of connected devices that support the HDMI CEC standard)
- 7 **HDMI Link** button (displays the Device Connections screen)
- 8 **Lens** button (cycles through lens adjustment options)
- 9 **Color Mode** button (displays the Color Mode menu)
- 10 Arrow buttons (navigates on-screen options)
- 11 **Enter** button (selects options)
- 12 **Default** button (returns selected setting to default value)
- 13 **Menu** button (accesses projector menu system)
- 14 **Memory** button (accesses the Memory menu)
- 15 **Frame Int** button (displays the Frame Interpolation menu)
- 16 **RGBCMY** button (displays the RGBCMY menu)
- 17 **HDR** button (displays the Dynamic Range menu)
- 18 **Pattern** button (displays a test pattern)
- 19 **Lens1** and **Lens2** buttons (loads the first or second saved lens position)
- 20 **Esc** button (cancels/exits functions or returns to previous screen)
- 21 **Image Enh** button (displays the Image Preset Mode menu)
- 22 **Fine/Fast** button (displays the Image Processing menu)
- 23 **Aspect** button (displays the Aspect menu)
- 24 **Blank** button (turns off video projection)
- 25 Illumination button (temporarily lights the remote control buttons)

Parent topic: [Projector Part Locations](#)

Setting Up the Projector

Follow the instructions in these sections to set up your projector for use.

[Projector Placement](#)

[Projector Connections](#)

[Attaching and Removing the Cable Cover](#)

[Installing Batteries in the Remote Control](#)

Projector Placement

You can place the projector on almost any flat surface to project an image.

You can also install the projector in a ceiling mount if you want to use it in a fixed location.

Keep these considerations in mind as you select a projector location:

- Place the projector on a sturdy, level surface or install it using a compatible mount.
- Place the projector parallel to the screen.
- Leave plenty of space around and under the projector for ventilation, and do not place it on top of or next to anything that could block the vents.
- Position the projector within reach of a grounded electrical outlet or extension cord.

[Projector Setup and Installation Options](#)

[Projection Distance](#)

Parent topic: [Setting Up the Projector](#)

Related tasks

[Changing the Projection Mode Using the Menus](#)

Projector Setup and Installation Options

You can set up or install your projector in the following ways:

Front

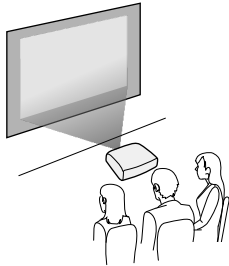

Rear

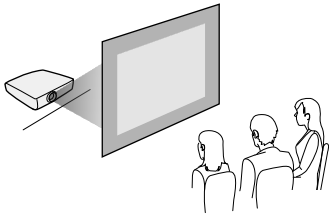

Front Ceiling

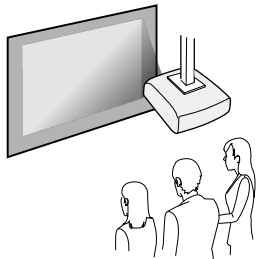

Rear Ceiling

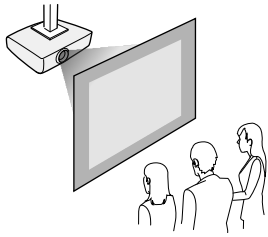

Wherever you set up the projector, make sure to position it squarely in front of the center of the screen, not at an angle, if possible. If the projector cannot be centered in front of the screen, use lens shift to reposition the image instead of using keystone correction for better image quality.

If you project from the ceiling or from the rear, be sure to select the correct **Projection** setting in the projector's Installation menu.

Parent topic: [Projector Placement](#)

Related references

[Installation Settings - Installation Menu](#)

Projection Distance

The distance at which you place the projector from the screen determines the approximate size of the image. The image size increases the farther the projector is from the screen, but can vary depending on the zoom factor, aspect ratio, and other settings.

Note: The closer the projector is placed to the screen, the brighter the image will be.

Use the tables here to determine approximately how far to place the projector from the screen based on the size of the projected image. (Conversion figures may have been rounded up or down.) You can also use the Projection Distance Calculator [here](#) (U.S.), [here](#) (Canada), or [here](#) (Caribbean).

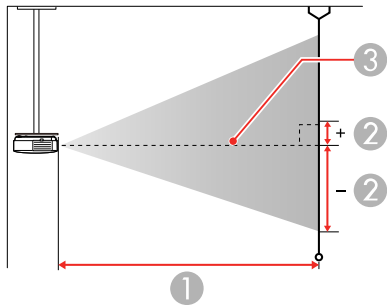
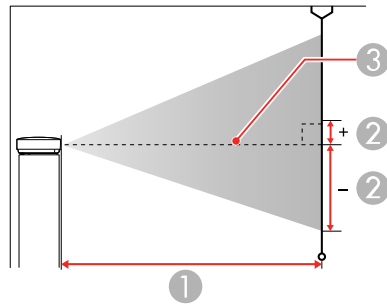

- 1 Projection distance
- 2 Distance from the center of the lens to the base of the screen
- 3 Center of the lens

16:9 Aspect Ratio Image or Screen

Screen or image size	Projection distance (1) Wide to Tele	Offset from lens center (2)
50 inches	58 to 123 inches (148 to 313 cm)	-35.9 to 11.3 inches (-91 to 29 cm)

Screen or image size	Projection distance (1) Wide to Tele	Offset from lens center (2)
60 inches	70 to 148 inches (178 to 376 cm)	-43 to 13.6 inches (-109 to 35 cm)
80 inches	94 to 198 inches (239 to 503 cm)	-57.4 to 18.2 inches (-146 to 46 cm)
100 inches	118 to 248 inches (300 to 630 cm)	-71.7 to 22.7 inches (-182 to 58 cm)
150 inches	178 to 373 inches (452 to 947 cm)	-107.6 to 34 inches (-273 to 86 cm)
200 inches	238 to 498 inches (604 to 1264 cm)	-143.4 to 45.4 inches (-364 to 115 cm)
250 inches	297 to 623 inches (756 to 1582 cm)	-179.3 to 56.7 inches (-455 to 144 cm)
300 inches	357 to 748 inches (908 to 1899 cm)	-215.2 to 68.1 inches (-547 to 173 cm)

4:3 Aspect Ratio Image or Screen

Screen or image size	Projection distance (1) Wide to Tele	Offset from lens center (2)
50 inches	72 to 151 inches (182 to 384 cm)	-43.9 to 13.9 inches (-111 to 35 cm)
60 inches	86 to 182 inches (219 to 462 cm)	-52.7 to 16.7 inches (-134 to 42 cm)
80 inches	115 to 243 inches (293 to 617 cm)	-70.2 to 22.2 inches (-178 to 56 cm)

Screen or image size	Projection distance (1) Wide to Tele	Offset from lens center (2)
100 inches	145 to 304 inches (368 to 772 cm)	-87.8 to 27.8 inches (-223 to 71 cm)
120 inches	174 to 365 inches (442 to 927 cm)	-105.3 to 33.3 inches (-268 to 85 cm)
150 inches	218 to 457 inches (554 to 1160 cm)	-131.7 to 41.7 inches (-334 to 106 cm)
200 inches	291 to 610 inches (740 to 1548 cm)	-175.6 to 55.6 inches (-446 to 141 cm)
220 inches	321 to 671 inches (814 to 1704 cm)	-193.1 to 61.1 inches (-491 to 155 cm)
244.8 inches	357 to 746 inches (906 to 1896 cm)	-214.8 to 68 inches (-546 to 173 cm)

16:10 Aspect Ratio Image or Screen

Screen or image size	Projection distance (1) Wide to Tele	Offset from lens center (2)
50 inches	63 to 133 inches (160 to 339 cm)	-38.6 to 12.2 inches (-98 to 31 cm)
60 inches	76 to 160 inches (193 to 407 cm)	-46.5 to 14.6 inches (-118 to 37 cm)
80 inches	102 to 214 inches (259 to 544 cm)	-62.2 to 19.7 inches (-158 to 50 cm)
100 inches	128 to 269 inches (324 to 682 cm)	-77.6 to 24.4 inches (-197 to 62 cm)

Screen or image size	Projection distance (1) Wide to Tele	Offset from lens center (2)
120 inches	154 to 322 inches (390 to 819 cm)	-92.9 to 29.5 inches (-236 to 75 cm)
150 inches	193 to 403 inches (489 to 1024 cm)	-116.1 to 36.6 inches (-295 to 93 cm)
200 inches	257 to 538 inches (653 to 1367 cm)	-155.1 to 49.2 inches (-394 to 125 cm)
250 inches	322 to 673 inches (817 to 1710 cm)	-193.7 to 61.4 inches (-492 to 156 cm)
277.2 inches	357 to 747 inches (907 to 1897 cm)	-215 to 68.1 inches (-546 to 173 cm)

Parent topic: [Projector Placement](#)

Projector Connections

See these sections to connect the projector to a variety of projection sources.

Caution: If you will use the projector at altitudes above 4921 feet (1500 m), turn on **High Altitude Mode** to ensure the projector's internal temperature is regulated properly. The cooling fans will run at a higher speed and will be slightly louder.

[Connecting to an HDMI Video Source](#)

[Connecting to a Computer for HDMI Video](#)

[Connecting to a Streaming Media Player](#)

[Connecting External Output Devices](#)

Parent topic: [Setting Up the Projector](#)

Related references

[Installation Settings - Installation Menu](#)

Connecting to an HDMI Video Source

If your video source has an HDMI port, you can connect it to the projector using an optional HDMI cable. The HDMI connection provides the best image quality.

Caution: Do not turn on the video source before connecting it to the projector. Doing so could damage the projector.

Note: When projecting images at 4K 120Hz, use an HDMI 2.1 rated cable (ultra-high speed). If you use an incompatible cable, images may not be displayed correctly. You can try correcting the images by changing the **EDID Mode** setting in the projector's Signal I/O menu.

1. Connect the HDMI cable to your video source's HDMI output port.
2. Connect the other end to one of the projector's HDMI ports. If you are connecting an optical HDMI cable, you must also connect the cable's USB power connector to the **Opt.HDMI (300mA)** port.

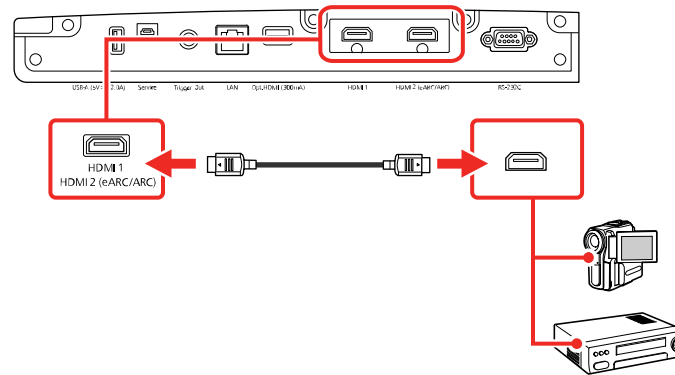

Note: When an audio/video source that meets the HDMI CEC standard is connected to the projector's HDMI port, you can use the projector's remote control to control certain features of the linked device by pressing the **HDMI Link** button on the remote control and setting **HDMI Link** to **On**.

Parent topic: [Projector Connections](#)

Connecting to a Computer for HDMI Video

If your computer has an HDMI port, you can connect it to the projector using an optional HDMI cable.

Note: To connect a Mac that does not include a compatible video output port, you need to obtain an adapter that allows you to connect to an input port on the projector. Contact Apple for compatible adapter options. To connect a smartphone or tablet, you may need to obtain an adapter that allows you to connect to the projector. This allows you to mirror your smartphone or tablet screens, watch movies, and more. Contact your device manufacturer for compatible adapter options.

1. Connect the HDMI cable to your computer's HDMI output port.
2. Connect the other end to one of the projector's HDMI ports. If you are connecting an optical HDMI cable, you must also connect the cable's USB power connector to the **Opt.HDMI (300mA)** port.

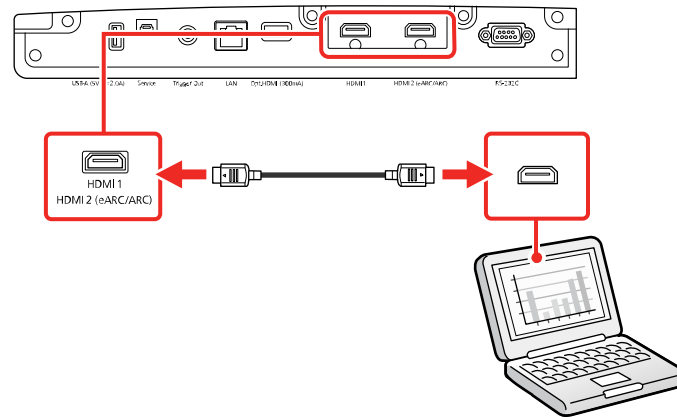

Parent topic: [Projector Connections](#)

Connecting to a Streaming Media Player

You can connect a streaming media player to the projector's HDMI port. By connecting the streaming media player's power supply USB cable, you can power the streaming media player from the projector.

1. Connect the streaming media player to an **HDMI** port.

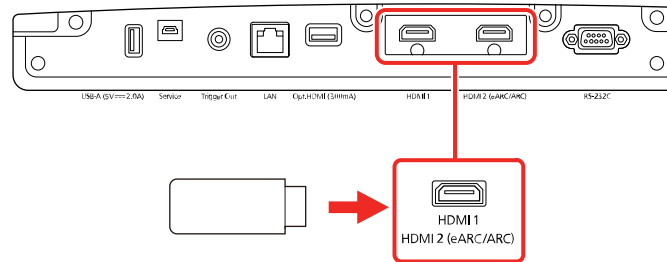

2. If necessary, connect the streaming media player's USB power supply cable to the **USB-A** port. Connect the other end of the cable to the USB port on the streaming media player.

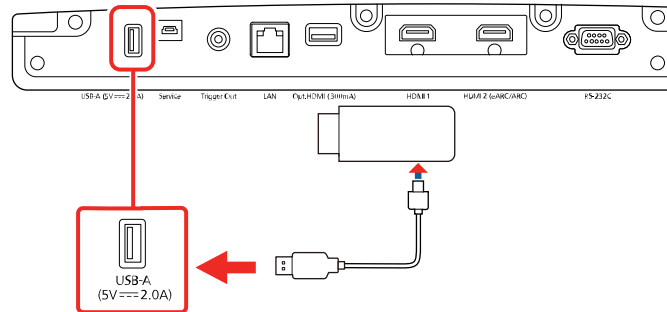

Parent topic: [Projector Connections](#)

Connecting External Output Devices

See these sections to connect the projector to external output devices.

[Connecting an A/V System or External Speakers Using HDMI ARC](#)

[Connecting to a Trigger Out Port](#)

Parent topic: [Projector Connections](#)

Connecting an A/V System or External Speakers Using HDMI ARC

If your A/V system or external speakers are eARC/ARC-compatible, you can connect them to the projector's **HDMI2 (ARC)** port using an optional HDMI cable with Ethernet.

Note: Make sure the **HDMI Link** setting is turned on in the projector's Signal I/O menu.

1. Connect the HDMI cable to the HDMI port on your A/V system or external speakers.
2. Connect the other end of the cable to the **HDMI2 (eARC/ARC)** port on the rear of the projector.

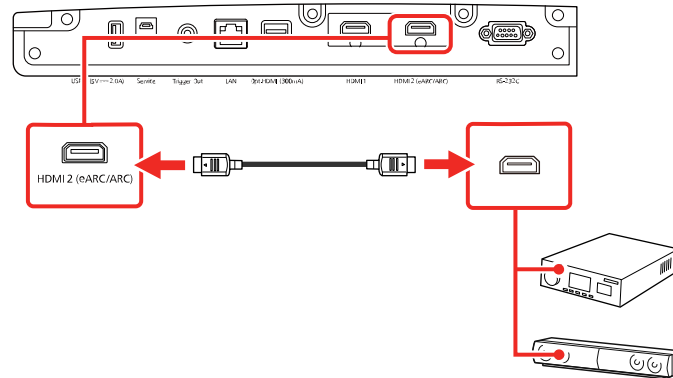

3. Adjust any necessary settings on the connected A/V system or external speakers. See your device's documentation for more information.

Parent topic: [Connecting External Output Devices](#)

Connecting to a Trigger Out Port

You can connect your projector to external devices such as motorized screens that support a trigger signal. When active, a 12V (200 mA maximum) signal is sent to the connected device while the projector is powered on. See the link below for cable specifications.

1. Connect a 3.5 mm mono or stereo mini-jack cable to the external device's trigger port. See your device's documentation for details.

2. Connect the other end to the projector's **Trigger Out** port.

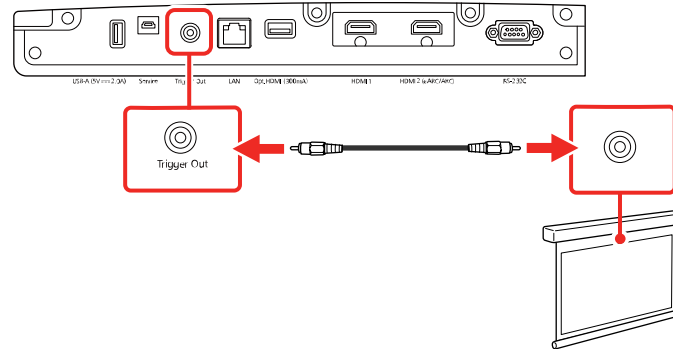

3. Turn on the **Trigger Out** setting in the projector's Operation menu.

Parent topic: [Connecting External Output Devices](#)

Related references

[General Projector Specifications](#)

[Feature Settings - Operation Menu](#)

Attaching and Removing the Cable Cover

You can attach the cable cover that came with your projector to hide the attached cables from view.

1. Carefully place the projector upside down on a flat, stable surface.

2. Bundle the cables together using a band or other fastener (not provided) and pass it through the cable holder as shown.

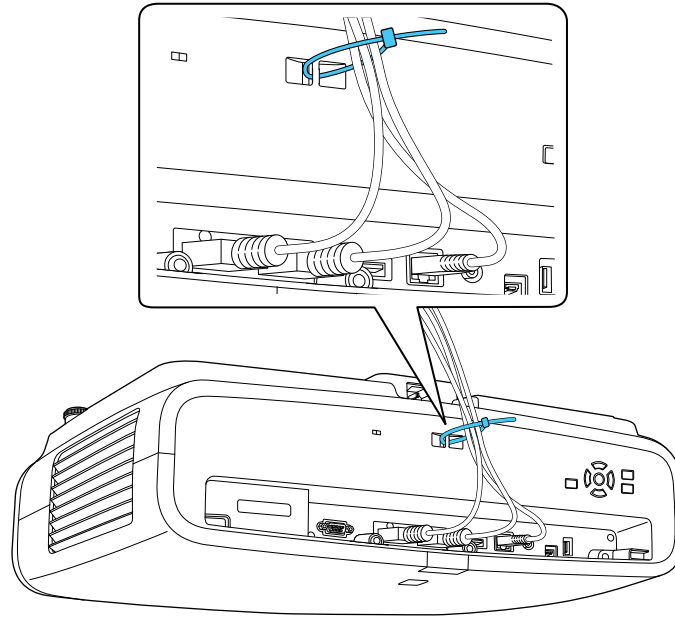

Caution: Do not bundle the power cord to the other cables. Otherwise, a fire may occur.

3. Place the cable cover on the projector as shown, guiding the cables through the notch on the base of the cable cover. Make sure the cable cover screws fit into the holes on the projector.

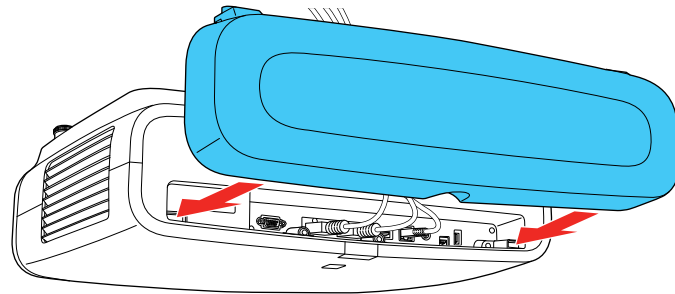

4. Tighten both cable cover screws.

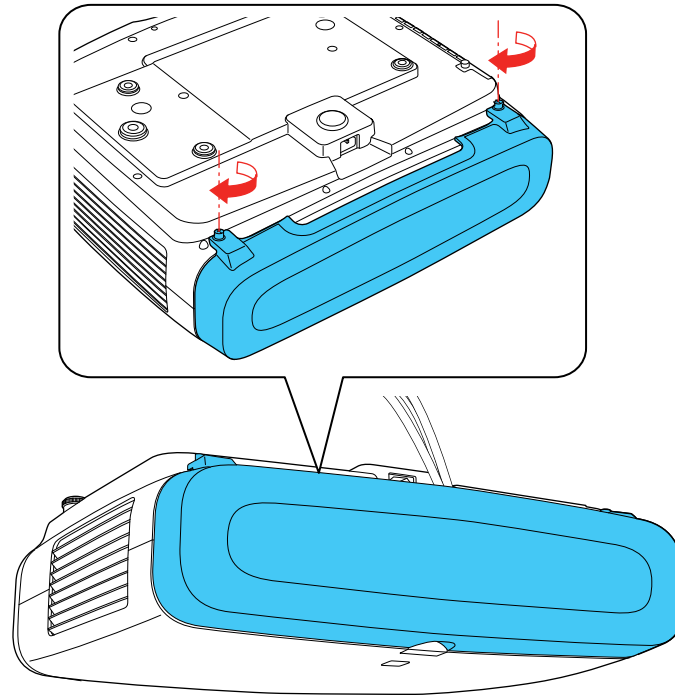

To remove the cover, loosen both screws and pull the cover off of the projector.

Parent topic: [Setting Up the Projector](#)

Installing Batteries in the Remote Control

The remote control uses the two AA batteries that came with the projector. Replace the batteries as soon as they run out.

Caution: Use only the type of batteries specified in this manual. Do not install batteries of different types, or mix new and old batteries.

1. Remove the battery cover.

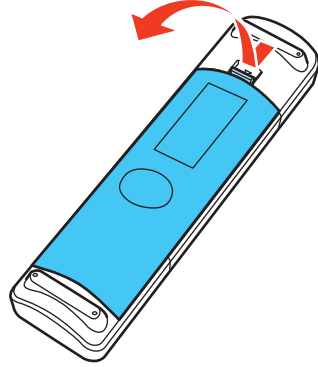

2. Insert the batteries with the + and – ends facing as shown.

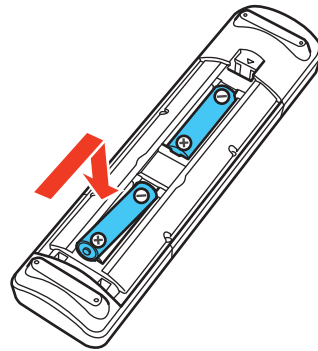

Warning: Make sure the batteries are inserted in the correct positions. If the batteries are not inserted correctly, they could explode or leak, causing a fire, injury, or damage to the product.

3. Replace the battery cover and press it down until it clicks into place.

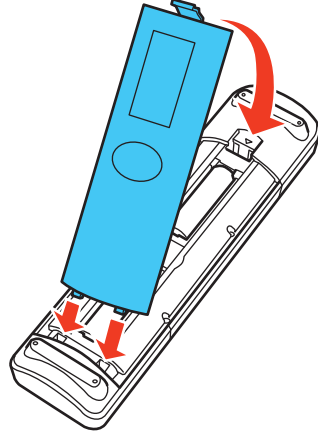

Warning: Dispose of used batteries according to local regulations. Do not expose batteries to heat or flame. Keep batteries out of the reach of children; they are choking hazards and are very dangerous if swallowed.

Parent topic: [Setting Up the Projector](#)

Monitoring and Controlling the Projector

Follow the instructions in these sections to monitor and control the projector over a network.

[Connecting to a Wired Network](#)

[Selecting Wired Network Settings](#)

Connecting to a Wired Network

To connect the projector to a wired local area network (LAN), use a 100Base-TX or 10Base-T network cable. To ensure proper data transmission, use a Category 5 shielded cable or higher.

1. Connect one end of the network cable to your network hub, switch, or router.
2. Connect the other end of the cable to the projector's **LAN** port.

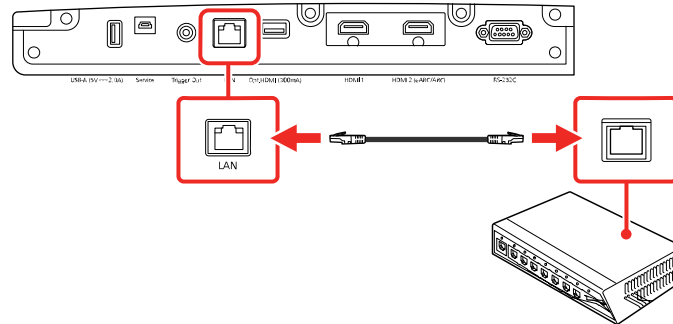

Parent topic: [Monitoring and Controlling the Projector](#)

Selecting Wired Network Settings

Before you can control the projector on your network, you must select the network settings for the projector using its menu system.

Note: Make sure you already connected the projector to your wired network using the **LAN** port.

1. Turn on the projector.
2. Press the **Menu** button.

3. Select the **Network** menu and press **Enter**.

Frequently Used Items	Control Panel Lock	Off
Image	Color Uniformity	
Signal I/O	Log Save Destination	USB and Internal Memory
Installation	Batch Setup Range	
Display	Language 	English
Operation	Information	
Management	Display Status	
	Reset Management Settings	
Network	Network	
Memory	Wired LAN Info.	
Initial/All Settings	Network Settings	
	Reset Network Settings	
	Memory	
	Image	
	Lens Position	
	Reset Memory Settings	
	Initial/All Settings	
	Reset All	

4. Select **Network Settings** and press **Enter**.

[Network Settings]	Return
Projector Name	EB000000
Wired LAN	
Projector Control	
	Set

5. Select **Projector Name** to enter a name to identify the projector over the network

Note: Use the displayed keyboard to enter the name. Press the arrow buttons on the remote control to highlight characters and press **Enter** to select them. Select **OK** when you are done.

6. Select **Wired LAN** and press **Enter**.

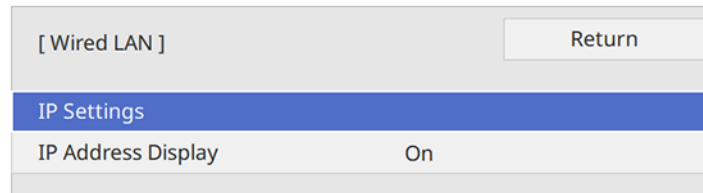

7. Select **IP Settings** and press **Enter**.
8. Select your IP Settings as necessary:
 - If your network assigns addresses automatically, select **On** as the **DHCP** setting.
 - If you must set addresses manually, select **Off** as the **DHCP** setting. Enter the projector's **IP Address**, **Subnet Mask**, and **Gateway Address** as needed.

Note: Use the displayed keypad to enter numbers. Press the arrow buttons on the remote control to highlight numbers and press **Enter** to select them. Select **OK** when you are done.

9. To prevent display of the IP address on the network information screen, select **Off** as the **IP Address Display** setting.
10. Select **Projector Control** and press **Enter**. Choose from the available options.
11. When you finish selecting settings, return to the **Network Settings** screen. Select **Set** and follow the on-screen instructions to save your settings and exit the menus.

[Projector Control Settings](#)

Parent topic: [Monitoring and Controlling the Projector](#)

Projector Control Settings

You can select the following settings for controlling the projector over a network.

Setting	Options	Description
PJLink	On Off	Set to On to enable the PJLink notification function

Setting	Options	Description
PJLink Password	Up 32 alphanumeric characters	Enter a password for using the PJLink protocol for projector control (do not use spaces or any symbols besides @)
Notified IP Address	Various IP addresses	Enter the IP address to receive the projector's operating status when the PJLink notification function is enabled. Enter the addresses using 0 to 255 for each address field. Do not use these addresses: 127.x.x.x or 224.0.0.0 through 255.255.255.255 (where x is a number from 0 to 255).
AMX Device Discovery	On Off	Set to On to allow AMX Device Discovery to detect the projector
Control4 SDDP	On Off	Set to On to allow device information to be acquired using Control4 Simple Device Discovery Protocol (SDDP)

Parent topic: [Selecting Wired Network Settings](#)

Using Basic Projector Features

Follow the instructions in these sections to use your projector's basic features.

[Turning On the Projector](#)

[Turning Off the Projector](#)

[Selecting the Language for the Projector Menus](#)

[Adjusting the Image Height](#)

[Adjusting the Image Position Using Lens Shift](#)

[Image Shape](#)

[Resizing the Image with the Zoom Feature](#)

[Focusing the Image with the Lens Button](#)

[Remote Control Operation](#)

[Selecting an Image Source](#)

[Projection Modes](#)

[Image Aspect Ratio](#)

[Color Mode](#)

[Adjusting Image Sharpness](#)

[Adjusting the Projector's Brightness Level](#)

[Turning On Dynamic Contrast](#)

[Adjusting the Color Temperature](#)

[Adjusting the RGB Offset and Gain](#)

[Adjusting Gamma](#)

[Adjusting the Hue, Saturation, and Brightness](#)

Turning On the Projector

Turn on the projector before you turn on the computer or video equipment you want to use.

1. Connect the power cord to the projector's power inlet.

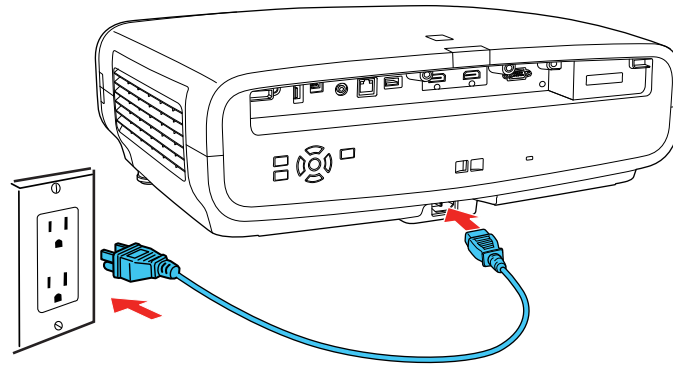

2. Plug the power cord into an electrical outlet.

Note: With **Direct Power On** turned on, the projector turns on as soon as you plug it in.

3. Press the power button on the projector or the **On** button on the remote control to turn on the projector.

The lens shutter opens and the Status light flashes blue as the projector warms up. Once the projector is warmed up, the Status light stops flashing and turns blue.

Warning: Never look into the projector lens when the laser is on. This can damage your eyes and is especially dangerous for children and pets. If you are using the remote control to turn the projector on, make sure no one is looking into the lens or in front of the projector before turning it on.

Caution: Make sure no objects are blocking the light from the projector lens. Objects blocking the lens for an extended time can melt and light that is reflected back into the lens can cause the projector to malfunction.

If you do not see a projected image right away, try the following:

- Turn on the connected computer or video device.
- Insert a DVD or other video media and press the play button, if necessary.
- Press the **Source** button on the projector or one of the Source buttons on the remote control.
- Change the screen output from the computer when using a laptop.

Parent topic: [Using Basic Projector Features](#)

Related references

[Feature Settings - Operation Menu](#)

Turning Off the Projector

Before turning off the projector, shut down any computer connected to it so you can see the computer display during shutdown.

Note: Turn off this product when not in use to prolong the life of the projector. Laser life will vary depending upon mode selected, environmental conditions, and usage. Brightness decreases over time.

1. Press the power button on the projector or the **Standby** button on the remote control.

The projector displays a shutdown confirmation screen.

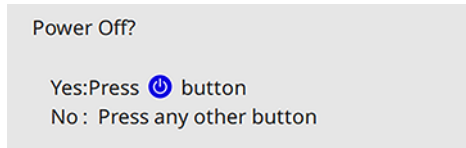

Power Off?

Yes: Press  button

No: Press any other button

Note: You can turn off the shutdown confirmation screen in the projector's Display menu.

2. Press the power button on the projector or the **Standby** button on the remote control again. (To leave it on, press any other button.)

The laser turns off and the lens shutter closes. The Status light flashes and then turns off.

3. To transport or store the projector, make sure the Status light is off, then unplug the power cord.

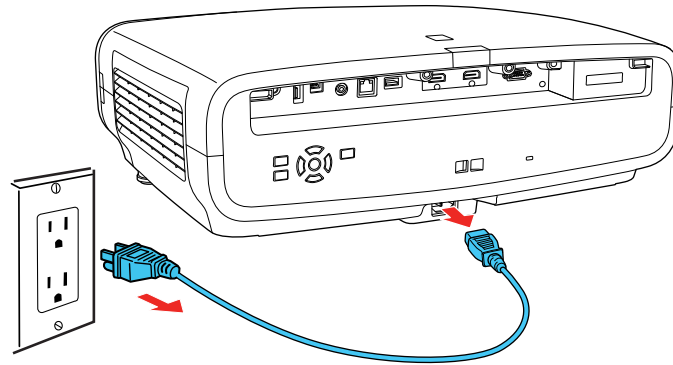

Caution: To avoid damaging the projector or laser, never unplug the power cord when the Status light is on or flashing.

Parent topic: [Using Basic Projector Features](#)

Related references

[Display Settings - Display Menu](#)

Related tasks

[Transporting the Projector](#)

Selecting the Language for the Projector Menu

If you want to view the projector's menus and messages in another language, you can change the Language setting.

1. Turn on the projector.
2. Press the **Menu** button.

3. Select the **Management** menu and press **Enter**.

Frequently Used Items	Management
Image	Lens Lock Off
Signal I/O	Child Lock Off
Installation	Control Panel Lock Off
Display	Color Uniformity
Operation	Log Save Destination USB and Internal Memory
Management	Batch Setup Range
Network	Language  English
Memory	Information
Initial/All Settings	Display Status
	Reset Management Settings
	Network
	Wired LAN Info.
	Network Settings
	Reset Network Settings
	Memory
	Image
	Lens Position

4. Select the **Language** setting and press **Enter**.
5. Select the language you want to use and press **Enter**.
6. Press **Menu** or **Esc** to exit the menus.

Parent topic: [Using Basic Projector Features](#)

Adjusting the Image Height

If you are projecting from a table or other flat surface, and the image is too high or low, you can adjust the image height using the projector's adjustable feet.

1. Turn on the projector and display an image.

2. If the image is tilted, rotate the front feet to adjust their height.

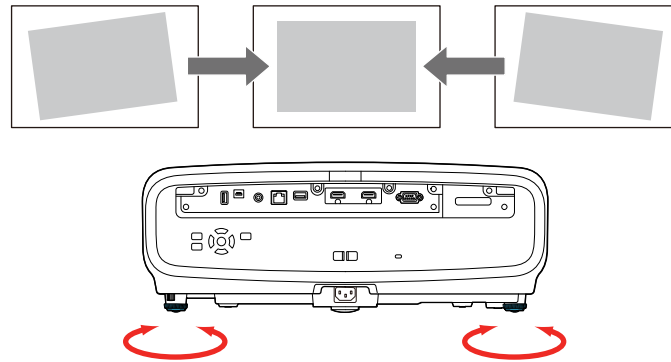

3. To adjust the position of the projected image further, press the **Lens** button on the remote control or projector until **Adjust Lens Shift** appears on the screen and follow the on-screen instructions.

If the projected image is unevenly rectangular, you need to adjust the image shape.

Parent topic: [Using Basic Projector Features](#)

Related concepts

[Image Shape](#)

Adjusting the Image Position Using Lens Shift

If you cannot install the projector directly in front of the screen, you can adjust the position of the projected image using the lens shift feature.

1. Turn on the projector and display an image.
2. Press the **Lens** button on the control panel or remote control.

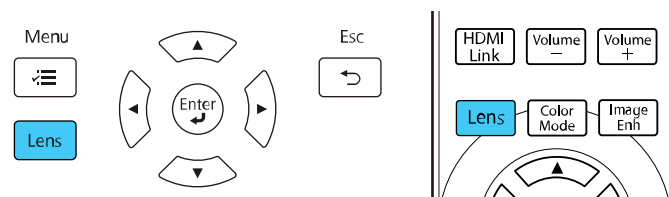

3. Press the **Lens** button repeatedly until **Adjust Lens Shift** appears on the screen.

4. Press the arrow buttons on the remote control or the control panel to adjust the position of the projected image as necessary.

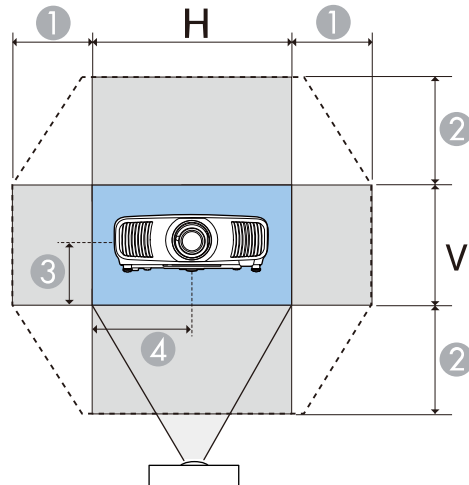

- 1 Maximum horizontal range ($H \times 47\%$)
- 2 Maximum vertical range ($V \times 96\%$)
- 3 $1/2$ the vertical height of the image
- 4 $1/2$ the horizontal width of the image

Note: You cannot move the image to both the horizontal and vertical maximum values.

5. When you are finished, press the **Esc** button on the control panel or remote control.

Note: When adjusting the image height, position the image lower than where you want it to be and then move it up. This will help prevent the image from moving down after adjustment. The image is clearest when the lens is at the home position. To move the lens to the home position, press and hold the **Lens** button on the remote control or control panel for at least three seconds.

Parent topic: [Using Basic Projector Features](#)

Image Shape

You can project an evenly rectangular image by placing the projector directly in front of the center of the screen and keeping it level. If you place the projector at an angle to the screen, or tilted up or down, or off to the side, you may need to correct the image shape for the best display quality.

For the best quality images, try to adjust the projector's position to achieve the correct image size and shape before using digital correction methods.

Note: If you are mounting the projector from the ceiling, use the adjustment controls on the mount at the time of installation.

[Correcting Image Shape with H/V-Keystone](#)

[Correcting Image Shape with Quick Corner](#)

[Correcting Image Shape with Point Correction](#)

Parent topic: [Using Basic Projector Features](#)

Correcting Image Shape with H/V-Keystone

You can use the projector's **H/V-Keystone** setting to correct the shape of an image that is unevenly rectangular on the sides.

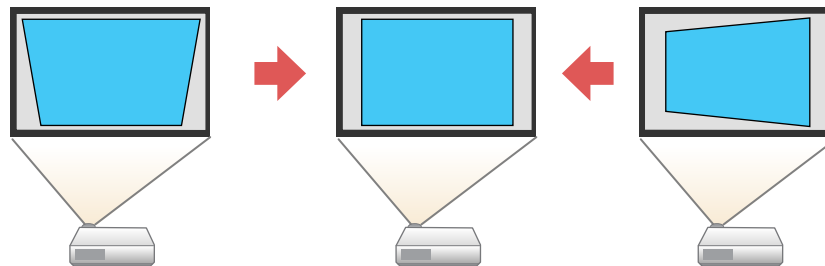

Note: Try adjusting the projector's placement and lens shift before using keystone correction. Digital image correction reduces the number of pixels in the image.

Note: You can correct images up to 30° left, right, up, or down.

Note: You cannot combine H/V-Keystone correction with other image shape correction methods.

1. Turn on the projector and display an image.

Note: You can also display a pattern to aid in adjusting the projected image using the **Pattern** button on the remote control.

2. Press the **Menu** button.
3. Select the **Installation** menu and press **Enter**.

Frequently Used Items	Installation	
Image	Test Pattern	
Signal I/O	Projection	Front/Ceiling
Installation	Geometry Correction	Point Correction
Display	Blanking	
Operation	High Altitude Mode	Off
Management	Reset Installation Settings	
Network	Display	
Memory	No-signal Screen	Blue
Initial/All Settings	Startup Screen	On
	Messages	On
	Menu Color	White
	Standby Confirmation	On
	Panel Alignment	Off
	Reset Display Settings	
	Operation	
	Direct Power On	Off
	Sleep Mode	On

4. Select the **Geometry Correction** setting and press **Enter**.
5. Select **H/V-Keystone** and press **Enter**. Select **Yes** and press **Enter** again.

You see the H/V-Keystone adjustment screen:

[H/V-Keystone]	Return	
V-Keystone	50	◀ —▶
H-Keystone	50	—

- Use the arrow buttons on the projector or the remote control to select between vertical and horizontal keystone correction and to adjust the image shape as necessary.

V-Keystone

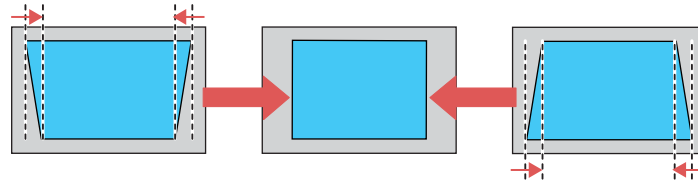

H-Keystone

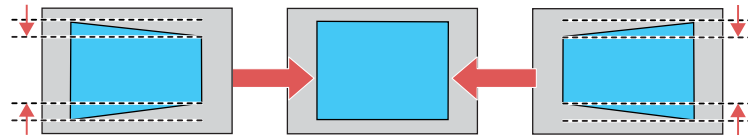

- When you are finished, press **Esc**.
After correction, your image is slightly smaller.

Parent topic: [Image Shape](#)

Related concepts

[Projector Placement](#)

Related tasks

[Adjusting the Image Position Using Lens Shift](#)

Correcting Image Shape with Quick Corner

You can use the projector's Quick Corner setting to correct the shape and size of an image that is unevenly rectangular on all sides.

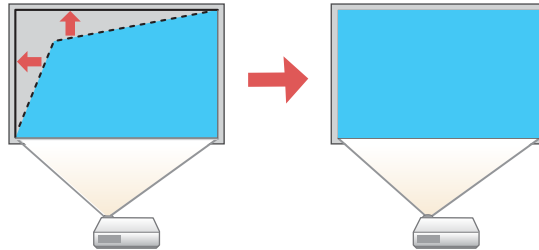

1. Turn on the projector and display an image.

Note: You can also display the pattern by pressing the **Pattern** button on the remote control.

2. Press the **Menu** button.

3. Select the **Installation** menu and press **Enter**.

Frequently Used Items	Installation		
Image	Test Pattern		
Signal I/O	Projection	Front/Ceiling	
Installation	Geometry Correction	Point Correction	
Display	Blanking		
Operation	High Altitude Mode	Off	
Management	Reset Installation Settings		
Network	Display		
Memory	No-signal Screen	Blue	
Initial/All Settings	Startup Screen	On	
	Messages	On	
	Menu Color	White	
	Standby Confirmation	On	
	Panel Alignment	Off	∨
	Reset Display Settings		
	Operation		
	Direct Power On	Off	
	Sleep Mode	On	∧

4. Select the **Geometry Correction** setting and press **Enter**.
5. Select the **Quick Corner** setting and press **Enter**.

You see the Quick Corner adjustment screen:

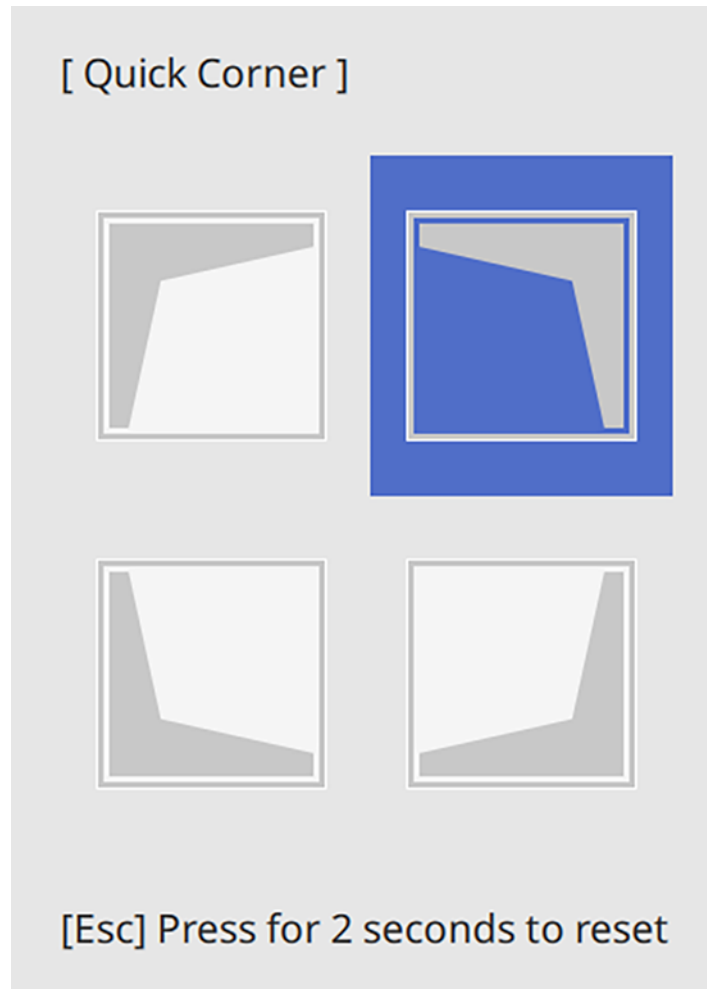

6. Use the arrow buttons on the projector or remote control to select the corner of the image you want to adjust. Then press **Enter**.

Note: To reset your adjustments, press and hold the **Esc** button for at least 2 seconds to display a reset screen. Then select **Yes**.

7. Press the arrow buttons to adjust the image shape as necessary. Press **Enter** to return to the area selection screen.
8. When you are finished, press **Esc**.

The **Geometry Correction** setting is now set to **Quick Corner** in the projector's Installation menu.

Parent topic: [Image Shape](#)

Correcting Image Shape with Point Correction

You can use the projector's Point Correction feature to fine-tune the image shape using points on a grid. This is useful for adjusting overlapping areas in multiple projected images that do not line up correctly.

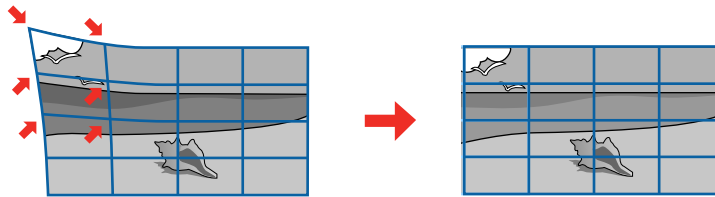

1. Turn on the projector and display an image.
2. Press the **Menu** button.

3. Select the **Installation** menu and press **Enter**.

Frequently Used Items	Installation		
Image	Test Pattern		
Signal I/O	Projection	Front/Ceiling	
Installation	Geometry Correction	Point Correction	
Display	Blanking		
Operation	High Altitude Mode	Off	
Management	Reset Installation Settings		
Network	Display		
Memory	No-signal Screen	Blue	
Initial/All Settings	Startup Screen	On	
	Messages	On	
	Menu Color	White	
	Standby Confirmation	On	
	Panel Alignment	Off	∨
	Reset Display Settings		
	Operation		
	Direct Power On	Off	
	Sleep Mode	On	∧

4. Select the **Geometry Correction** setting and press **Enter**.
5. Select the **Point Correction** setting and press **Enter**.

Note: If you see a confirmation message, select **Yes** and press **Enter**.

6. Select **Point Correction** again and press **Enter**.

Note: For fine tuning, select **Quick Corner** to roughly correct the shape and size of an image and then select **Point Correction** to adjust them more precisely.

You see a grid on the projected image.

Note: If you want to change the color of the grid lines, select the **Pattern Color** setting and select a color.

7. Use the arrow buttons to move to the point on the grid that you want to adjust and press **Enter**.

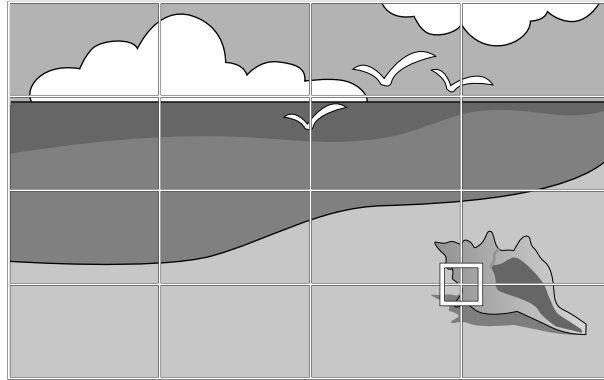

8. Use the arrow buttons as necessary to correct the image shape.

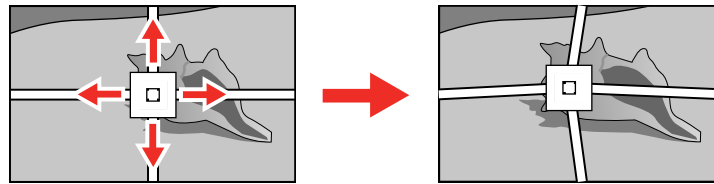

9. Press **Esc** to return to the previous screen and select another point to correct, if necessary.
10. When you are finished, press the **Esc** button.

Parent topic: [Image Shape](#)

Resizing the Image with the Zoom Feature

You can adjust the size of the projected image using the zoom feature.

1. Turn on the projector and display an image.

2. Press the **Lens** button on the control panel or remote control.

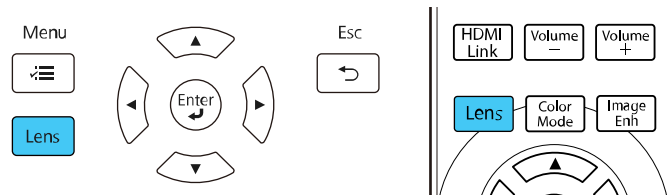

3. Press the **Lens** button repeatedly until **Adjust Zoom** is displayed on the screen.
4. Press and hold the left or right arrow button on the control panel or remote control to resize the image.
5. Press the **Esc** button on the control panel or remote control when finished.

Parent topic: [Using Basic Projector Features](#)

Focusing the Image with the Lens Button

You can adjust the sharpness of the projected image using the focus feature.

1. Turn on the projector and display an image.
2. Press the **Lens** button on the control panel or remote control.

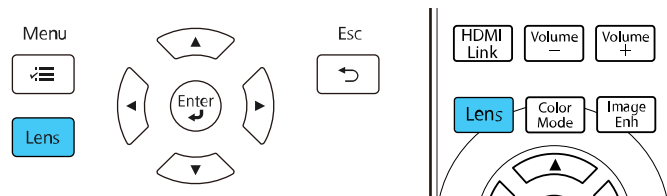

3. Press the **Lens** button repeatedly until **Adjust Focus** is displayed on the screen.
4. Press and hold the left or right arrow button on the control panel or remote control to focus the image.
5. Press the **Esc** button on the control panel or remote control when finished.

Parent topic: [Using Basic Projector Features](#)

Remote Control Operation

The remote control lets you control the projector from almost anywhere in the room. You can point it at the screen, or the front or back of the projector.

Make sure that you aim the remote control at the projector's receivers within the distance and angles listed here.

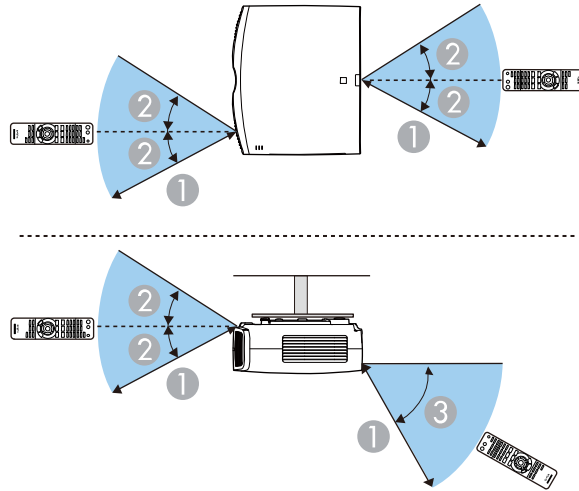

- 1 32 feet (10 m)
- 2 $\pm 30^\circ$
- 3 60°

Note: Avoid using the remote control in conditions with bright fluorescent lights or in direct sunlight, or the projector may not respond to commands. If you will not use the remote control for a long time, remove the batteries.

Parent topic: [Using Basic Projector Features](#)

Selecting an Image Source

If you connected multiple image sources to the projector, such as a computer and DVD player, you may want to switch from one image source to the other.

1. Make sure the connected image source you want to use is turned on.
2. For video image sources, insert a DVD or other video media and press its play button, if necessary.
3. Do one of the following:
 - Press the **Source** button on the projector until you see the image from the source you want.

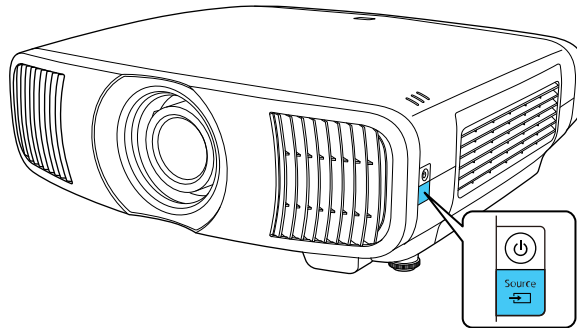

- Press the button for the source you want on the remote control.

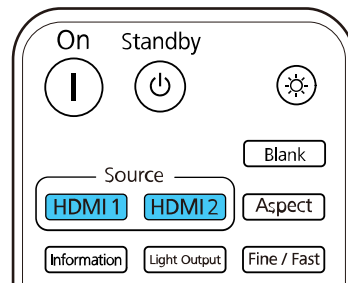

Parent topic: [Using Basic Projector Features](#)

Projection Modes

Depending on how you positioned the projector, you may need to change the projection mode so your images project correctly.

- **Front** (default setting) lets you project from a table in front of the screen.
- **Front/Ceiling** flips the image over top-to-bottom to project upside-down from a ceiling or wall mount.

- **Rear** flips the image horizontally to project from behind a translucent screen.
- **Rear/Ceiling** flips the image over top-to-bottom and horizontally to project from the ceiling and behind a translucent screen.

Changing the Projection Mode Using the Menu

Parent topic: [Using Basic Projector Features](#)

Changing the Projection Mode Using the Menu

You can change the projection mode to flip the image over top-to-bottom and/or left-to-right using the projector menus.

1. Turn on the projector and display an image.
2. Press the **Menu** button.
3. Select the **Installation** menu and press **Enter**.

Frequently Used Items	Installation	
Image	Test Pattern	
Signal I/O	Projection	Front/Ceiling
Installation	Geometry Correction	Point Correction
Display	Blanking	
Operation	High Altitude Mode	Off
Management	Reset Installation Settings	
Network	Display	
Memory	No-signal Screen	Blue
Initial/All Settings	Startup Screen	On
	Messages	On
	Menu Color	White
	Standby Confirmation	On
	Panel Alignment	Off
	Reset Display Settings	
	Operation	
	Direct Power On	Off
	Sleep Mode	On

4. Select the **Projection** setting and press **Enter**.
5. Select a projection mode and press **Enter**.
6. Press **Menu** or **Esc** to exit the menus.

Parent topic: [Projection Modes](#)

Related concepts

[Projector Placement](#)

Image Aspect Ratio

The projector can display images in different width-to-height ratios called aspect ratios. Normally the input signal from your video source determines the image's aspect ratio. However, for certain images you can change the aspect ratio to fit your screen by pressing a button on the remote control.

[Changing the Image Aspect Ratio](#)

[Available Image Aspect Ratios](#)

Parent topic: [Using Basic Projector Features](#)

Changing the Image Aspect Ratio

You can change the aspect ratio of the displayed image to resize it.

Note: The available aspect ratio setting varies depending on the input signal.

1. Turn on the projector and switch to the image source you want to use.
2. Press the **Aspect** button on the remote control.

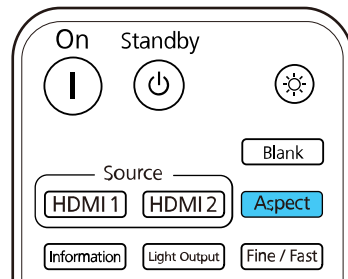

A list of the available aspect ratios appears.

3. Select the aspect ratio you want and press **Enter**.
4. Press **Menu** or **Esc** to exit the menus.

Parent topic: [Image Aspect Ratio](#)

Available Image Aspect Ratios

You can select the following image aspect ratios, depending on the input signal from your image source.

Note: Selecting an aspect ratio other than the ratio from the input signal may distort the projected image.

Aspect ratio setting	Description
Auto	Automatically sets the aspect ratio according to the input signal (this setting is recommended in most cases).
Full	Displays images using the full width of the projection area, but does not maintain the aspect ratio and can distort the image.
Zoom	Displays images using the full width of the projection area and maintains the aspect ratio of the image, but can cut off parts of the image.
Anamorphic Wide	Displays images that have a 2.40:1 aspect ratio when using a commercially available anamorphic lens. Set the Overscan setting in the projector's Signal I/O menu to Off or the image will not display correctly.
Horiz. Squeeze	Displays images using the full width of the projection area when using a commercially available anamorphic lens.

Parent topic: [Image Aspect Ratio](#)

Related references

[Input Signal Settings - Signal I/O Menu](#)

Color Mode

The projector offers different Color Modes to provide optimum brightness, contrast, and color for a variety of viewing environments and image types. You can select a mode designed to match your image and environment, or experiment with the available modes.

[Changing the Color Mode](#)

[Available Color Modes](#)

Parent topic: [Using Basic Projector Features](#)

Changing the Color Mode

You can change the projector's Color Mode using the remote control to optimize the image for your viewing environment.

1. Turn on the projector and switch to the image source you want to use.
2. If you are projecting from a DVD player or other video source, insert a disc or other video media and press the play button, if necessary.
3. Press the **Color Mode** button on the remote control.

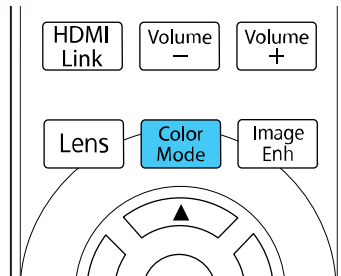

A list of available Color Modes appears.

4. Select the color mode you want and press **Enter**.
5. Press **Menu** or **Esc** to exit the menus.

Parent topic: [Color Mode](#)

Available Color Modes

You can set the projector to use these Color Modes, depending on the input source you are using:

Color Mode	Description
Dynamic	Best for prioritizing brightness
Vivid	Best for projecting in a bright environment
Bright Cinema	Best for projecting movies in a bright environment
Cinema	Best for projecting movies in a dark environment
B&W Cinema	Best for projecting black-and-white movies
Natural	Best for adjusting the image color

Parent topic: [Color Mode](#)

Adjusting Image Sharpness

You can adjust the outline of an image by adjusting its sharpness.

1. Turn on the projector and display an image.
2. Press the **Menu** button.
3. Select the **Image** menu and press **Enter**.

Frequently Used Items	Image	
Image	Color Mode	Presentation
Signal I/O	Brightness	50
Installation	Contrast	50
Display	Color Saturation	50
Operation	Tint	50
Management	Sharpness	
Network	White Balance	
Memory	Frame Interpolation	Off
Initial/All Settings	Light Output	100 %
	Dynamic Contrast	Off
	Deinterlacing	Off
	Image Enhancement	
	Scene Adaptive Gamma	5
	Gamma	0
	RGBCMY	
	Reset to Defaults	
	Source	Computer1
	Aspect	Auto

4. Select the **Sharpness** setting and press **Enter**.
5. Choose from the following options:
 - **Standard**: enhances outlines for the entire image, including the **Thin Line Enhancement** and **Thick Line Enhancement** settings.
 - **Thin Line Enhancement**: enhances details such as hair and clothing patterns
 - **Thick Line Enhancement**: enhances backgrounds and larger elements
6. Use the left and right arrow buttons to adjust the sharpness values.

7. Press **Menu** or **Esc** to exit the menus.

Parent topic: [Using Basic Projector Features](#)

Adjusting the Projector's Brightness Level

You can adjust the brightness of your projector's light source.

1. Turn on the projector and switch to the image source you want to use.
2. Press the **Light Output** button on the remote control.

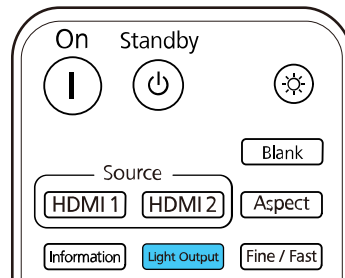

Note: You can also access this setting from the projector's Image menu.

3. Use the left and right arrow buttons to adjust the brightness.

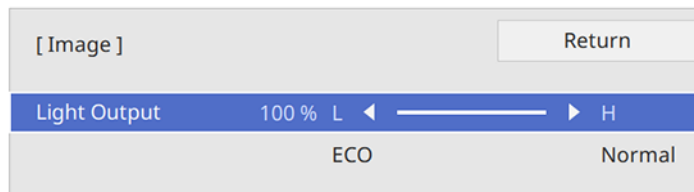

Note: Press the **Default** button on the remote control to return to the default setting.

4. Press **Menu** or **Esc** to exit the menus.

Parent topic: [Using Basic Projector Features](#)

Turning On Dynamic Contrast

You can turn on the **Dynamic Contrast** setting to automatically optimize the image luminance. This improves the image contrast based on the brightness of the content you project.

1. Turn on the projector and switch to the image source you want to use.
2. Press the **Menu** button.
3. Select the **Image** menu and press **Enter**.

Frequently Used Items	Image	
Image	Color Mode	Presentation
Signal I/O	Brightness	50
Installation	Contrast	50
Display	Color Saturation	50
Operation	Tint	50
Management	Sharpness	
Network	White Balance	
Memory	Frame Interpolation	Off
Initial/All Settings	Light Output	100 %
	Dynamic Contrast	Off
	Deinterlacing	Off
	Image Enhancement	
	Scene Adaptive Gamma	5
	Gamma	0
	RGBCMY	
	Reset to Defaults	
	Source	Computer1
	Aspect	Auto

4. Select the **Dynamic Contrast** setting, choose one of the following options, and press **Enter**:
 - **Normal** to adjust brightness at the standard speed.
 - **High Speed** to adjust brightness as soon as the scene changes.
5. Press **Menu** or **Esc** to exit the menus.

Parent topic: [Using Basic Projector Features](#)

Adjusting the Color Temperature

You can change the overall color tone if the image contains a bluish or reddish tone.

1. Turn on the projector and display an image.
2. Press the **Menu** button.
3. Select the **Image** menu and press **Enter**.

Frequently Used Items	Image	
Image	Color Mode	Presentation
Signal I/O	Brightness	50
Installation	Contrast	50
Display	Color Saturation	50
Operation	Tint	50
Management	Sharpness	
Network	White Balance	
Memory	Frame Interpolation	Off
Initial/All Settings	Light Output	100 %
	Dynamic Contrast	Off
	Deinterlacing	Off
	Image Enhancement	
	Scene Adaptive Gamma	5
	Gamma	0
	RGBCMY	
	Reset to Defaults	
	Source	Computer1
	Aspect	Auto

4. Select **White Balance** and press **Enter**.
5. Select the **Color Temp.** setting and press **Enter**.

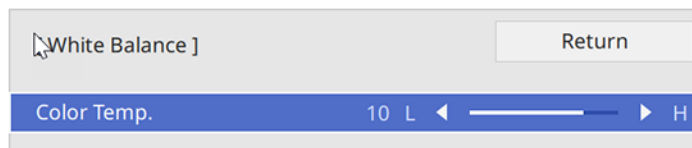

6. Use the left and right arrow buttons to adjust the color temperature. Higher values increase the blue tint, and lower values increase the red tint.

Note: Press the **Default** button on the remote control to return to the default setting.

7. Press **Menu** or **Esc** to exit the menus.

Parent topic: [Using Basic Projector Features](#)

Adjusting the RGB Offset and Gain

You can adjust the brightness of darker and brighter areas of the image by adjusting the **Offset** and **Gain** settings for the individual image colors.

Note: These settings should be set by a professional color calibrator using specialized color calibration tools in a controlled lighting environment.

1. Turn on the projector and display an image.
2. Press the **Menu** button.
3. Select the **Image** menu and press **Enter**.

Frequently Used Items	Image	
Image	Color Mode	Presentation
Signal I/O	Brightness	50
Installation	Contrast	50
Display	Color Saturation	50
Operation	Tint	50
Management	Sharpness	
Network	White Balance	
Memory	Frame Interpolation	Off
Initial/All Settings	Light Output	100 %
	Dynamic Contrast	Off
	Deinterlacing	Off
	Image Enhancement	
	Scene Adaptive Gamma	5
	Gamma	0
	RGBCMY	
	Reset to Defaults	
	Source	Computer1
	Aspect	Auto

4. Select **White Balance** and press **Enter**.

5. Select the **Custom** setting and press **Enter**.

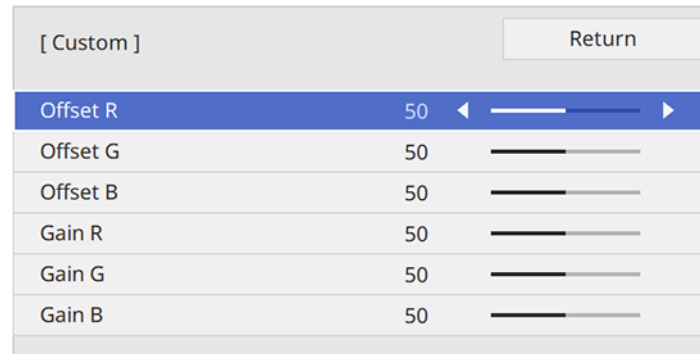

6. Do the following as necessary for each color (Red, Green, and Blue):

- To adjust the brightness of dark areas, adjust the **Offset** setting.
- To adjust the brightness of bright areas, adjust the **Gain** setting.

Higher values make the image brighter but can decrease shading details, while lower values make the image darker but can increase the visibility of details.

Note: Press the **Default** button on the remote control to return to the default setting.

7. Press **Menu** or **Esc** to exit the menus.

Parent topic: [Using Basic Projector Features](#)

Adjusting Gamma

You can correct differences in projected image colors that occur between different image sources.

Note: These settings should be set by a professional color calibrator using specialized color calibration tools in a controlled lighting environment.

Note: To optimize the color tone according to the scene and obtain a more vivid image, adjust the **Scene Adaptive Gamma** setting in the projector's Image menu.

1. Turn on the projector and switch to the image source you want to use.

2. Press the **Menu** button.
3. Select the **Image** menu and press **Enter**.

Frequently Used Items	Image	
Image	Color Mode	Presentation
Signal I/O	Brightness	50
Installation	Contrast	50
Display	Color Saturation	50
Operation	Tint	50
Management	Sharpness	
Network	White Balance	
Memory	Frame Interpolation	Off
Initial/All Settings	Light Output	100 %
	Dynamic Contrast	Off
	Deinterlacing	Off
	Image Enhancement	
	Scene Adaptive Gamma	5
	Gamma	0
	RGBCMY	
	Reset to Defaults	
	Source	Computer1
	Aspect	Auto

4. Select **Gamma** and press **Enter**.

[Gamma]
Return

2
1
✓ 0
-1
-2
Custom
Reset

The projected image freezes.

5. Select and adjust the correction value.

When you select a smaller value, you can reduce the overall brightness of the image to make the image sharper. When you select a larger value, the dark areas of images become brighter, but the color saturation for lighter areas may become weaker.

6. If you want to make finer adjustments, select **Custom** and press **Enter**.

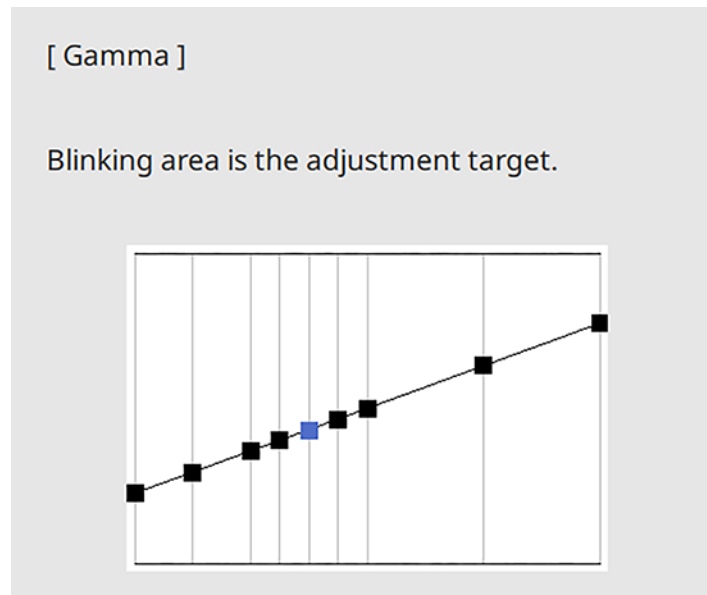

7. Press the left or right arrow button to select the tone you want to change, then press the up or down arrow button to adjust the tone and press **Enter**.

Note: Select **Reset** to reset the Gamma settings.

8. Press **Menu** or **Esc** to exit the menus.

Parent topic: [Using Basic Projector Features](#)

Related references

[Image Quality Settings - Image Menu](#)

Adjusting the Hue, Saturation, and Brightness

You can adjust the hue, saturation, and brightness settings for individual image colors.

Note: These settings should be set by a professional color calibrator using specialized color calibration tools in a controlled lighting environment.

1. Turn on the projector and switch to the image source you want to use.
2. Press the **RBGCMY** button on the remote control.

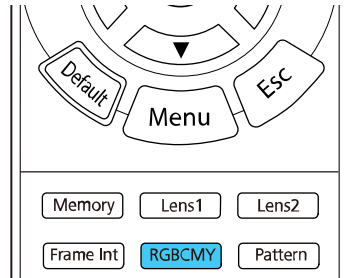

Note: You can also access this setting from the projector's Image menu.

3. Select the color to adjust and press **Enter**.

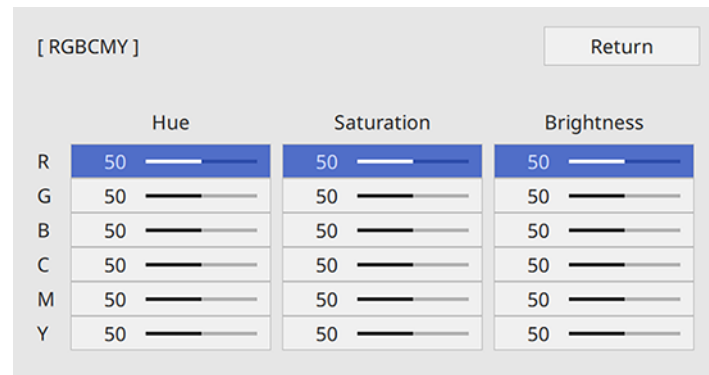

The selected color fills the screen and the adjustment menu appears.

4. Do the following as necessary for each setting:
 - To adjust the overall hue of the color (bluish, greenish, reddish), adjust the **Hue** setting.
 - To adjust the overall vividness of the color, adjust the **Saturation** setting.
 - To adjust the overall brightness of the color, adjust the **Brightness** setting.

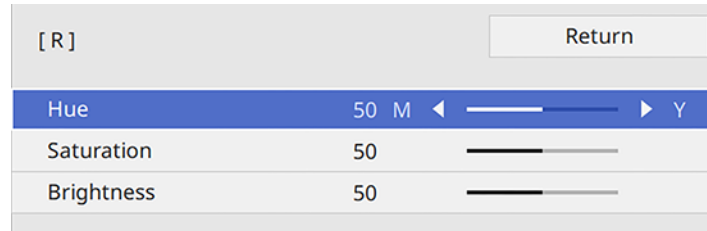

5. Press **Menu** or **Esc** to exit the menus.

Parent topic: [Using Basic Projector Features](#)

Related references

[Image Quality Settings - Image Menu](#)

Adjusting Projector Features

Follow the instructions in these sections to use your projector's feature adjustments.

[Operating Connected Devices Using the HDMI Link Features](#)

[Shutting Off the Picture Temporarily](#)

[Projector Security Features](#)

[Using Advanced Image Adjustment Features](#)

[Saving Settings to Memory and Using Saved Settings](#)

[Copying Menu Settings Between Projectors](#)

Operating Connected Devices Using the HDMI Link Features

You can use the remote control to control certain features of devices connected to the projector's HDMI ports.

Note: The connected device and cable must meet the HDMI CEC standard. Up to three devices can be connected at the same time.

1. Press the **HDMI Link** button on the remote control.

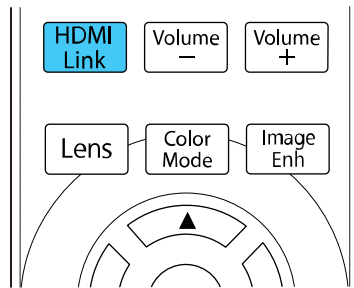

Note: You can also access this setting from the projector's Signal I/O menu.

2. Select the **HDMI Link** setting and press **Enter**.

3. Select **On** and press **Enter**.

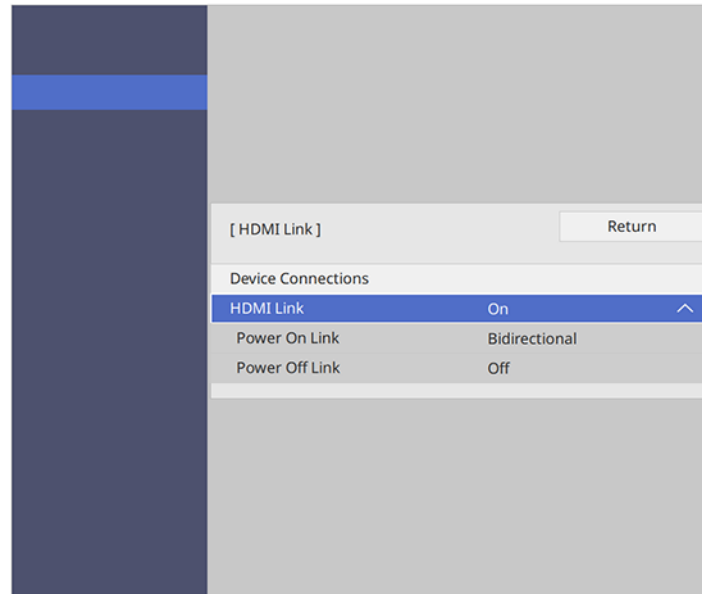

4. Select **Device Connections** and press **Enter**.
5. Select the device you want to control and project images from and press **Enter**.

Note: A linked device is indicated with a blue mark.

6. Select the following HDMI Link options as necessary:
 - **Power On Link:** Select what happens when you turn on the projector or linked device. Select **PJ - > Device** or **Bidirectional** to turn the linked device on when the projector is turned on, or **Device - > PJ** or **Bidirectional** to turn the projector on when the linked device is turned on.
 - **Power Off Link:** Select whether linked devices are turned off when the projector is turned off. This option only works when the connected device's CEC power link function is enabled.

Note: Some linked devices and their functions may not operate, even if they meet the HDMI CEC standard. See the device's documentation for more information.

7. Press **Menu** or **Esc** to exit the menus.

Parent topic: [Adjusting Projector Features](#)

Related references

[Input Signal Settings - Signal I/O Menu](#)

Shutting Off the Picture Temporarily

You can temporarily turn off the projected picture if you want to redirect your audience's attention during a presentation. Any video action continues to run, however, so you cannot resume projection at the point that you stopped it.

1. Press the **Blank** button on the remote control to temporarily stop projection.

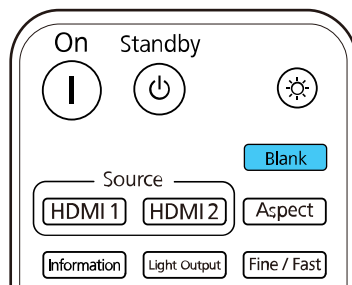

2. To turn the picture back on, press the **Blank** button again.

Parent topic: [Adjusting Projector Features](#)

Projector Security Features

You can secure your projector to deter theft or prevent unintended use by setting up the following security features:

- Lens lock to prevent changing the zoom, focus, or lens shift settings.
- Button lock security to block operation of the projector using the buttons on the control panel.
- Security cabling to physically cable the projector in place.

[Locking the Projector's Lens Settings and Buttons](#)

[Installing a Security Cable](#)

Parent topic: [Adjusting Projector Features](#)

Locking the Projector's Lens Settings and Buttons

You can lock the buttons on the projector's control panel to prevent anyone from using the projector. You can also lock the zoom, focus, and lens shift settings to prevent them from being adjusted.

Note: You can use the remote control to control the projector when the control panel buttons are locked.

1. Press the **Menu** button.
2. Select the **Management** menu and press **Enter**.

Frequently Used Items	Management
Image	Lens Lock Off
Signal I/O	Child Lock Off
Installation	Control Panel Lock Off
Display	Color Uniformity
Operation	Log Save Destination USB and Internal Memory
Management	Batch Setup Range
Network	Language  English
Memory	Information
Initial/All Settings	Display Status
	Reset Management Settings
	Network
	Wired LAN Info.
	Network Settings
	Reset Network Settings
	Memory
	Image
	Lens Position

3. Select one of these lock types and press **Enter**:
 - To lock the zoom, focus, and lens shift settings, select **Lens Lock**.
 - To lock the projector's power button, select **Child Lock**. To turn the projector on, you must press the power button for longer than three seconds. You must restart the projector to enable this lock setting.

Note: **Child Lock** does not prevent the projector from turning on when the power cord is connected if the **Direct Power On** setting is enabled in the projector's Operation menu.

- To lock all buttons, select **Control Panel Lock > Full Lock**.
- To lock all buttons except the power button, select **Control Panel Lock > Except for Power**.

Note: A message is displayed on the screen if any control panel buttons are pressed while this setting is enabled.

You see a confirmation prompt.

4. Select **Yes** and press **Enter**.

[Unlocking the Projector's Buttons](#)

Parent topic: [Projector Security Features](#)

Unlocking the Projector's Buttons

If the projector's buttons have been locked, hold the **Enter** button on the projector's control panel for 7 seconds to unlock them. You can also set the **Control Panel Lock** setting to **Off** in the Management menu.

Parent topic: [Locking the Projector's Lens Settings and Buttons](#)

Related references

[Administration Settings - Management Menu](#)

Installing a Security Cable

You can use the security slot on the back of the projector to attach a Kensington lock. See your local computer or electronics dealer for purchase information.

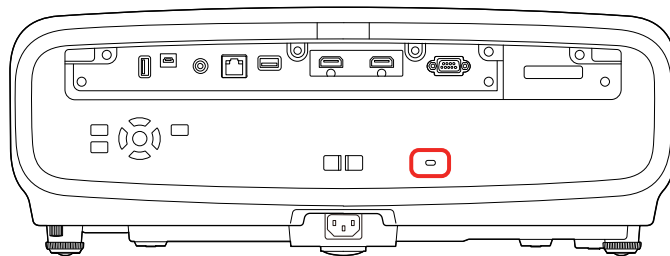

Parent topic: [Projector Security Features](#)

Using Advanced Image Adjustment Features

Follow the instructions in these sections to use your projector's advanced image adjustments.

Note: Not all adjustments may be available depending on the projection mode and input signal.

[Using Frame Interpolation](#)

[Creating Image Presets](#)

[Adjusting the Color Convergence \(Panel Alignment\)](#)

[Adjusting the Color Tone \(Color Uniformity\)](#)

Parent topic: [Adjusting Projector Features](#)

Using Frame Interpolation

You can use the projector's Frame Interpolation feature to smooth fast-moving video by comparing consecutive image frames and inserting an intermediate image frame between them.

Note: This feature is only available when **Image Processing** is set to **Fine** in the projector's Signal I/O menu and 4K 100/120Hz signals are not being projected.

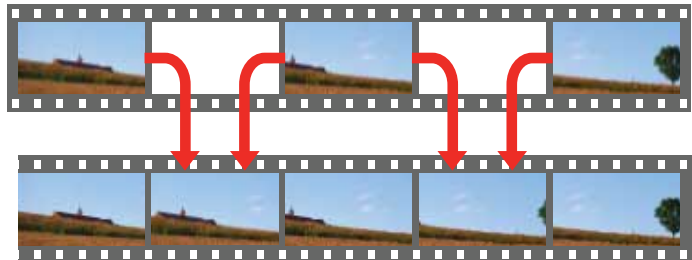

1. Press the **Frame Int** button on the remote control.

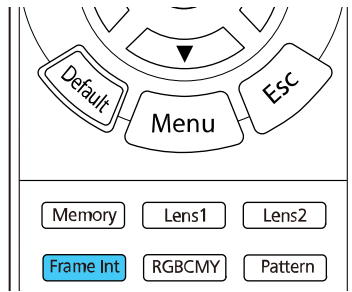

Note: You can also access this setting from the projector's Image menu.

2. Select the level of interpolation and press **Enter**.

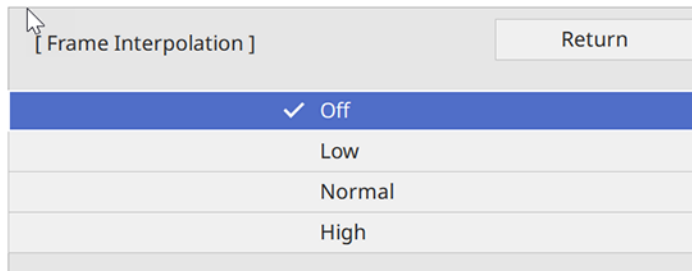

3. Press **Menu** or **Esc** to exit the menus.

Note: If your resulting images contain noise, turn off the **Frame Interpolation** setting.

Parent topic: [Using Advanced Image Adjustment Features](#)

Related references

[Input Signal Settings - Signal I/O Menu](#)

[Image Quality Settings - Image Menu](#)

Creating Image Presets

You can quickly optimize your projected image by selecting image adjustment settings and saving them as a preset you can reuse later. You can save up to five presets.

1. Turn on the projector and switch to the image source you want to use.
2. Press the **Image Enh** button on the remote control.

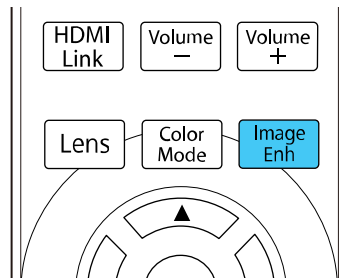

Note: You can also access this setting from the projector's Image menu.

3. Select the preset you want to adjust and press **Enter**.

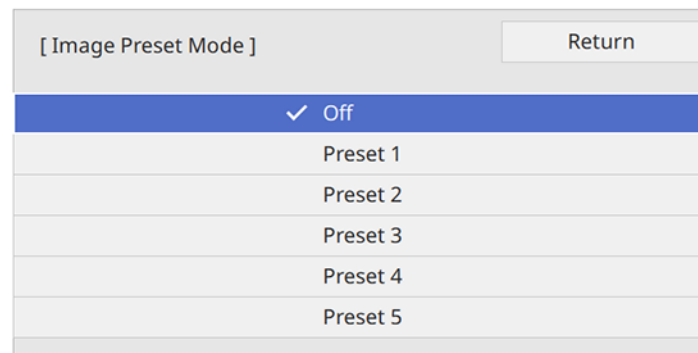

4. Adjust each setting for the preset as necessary.

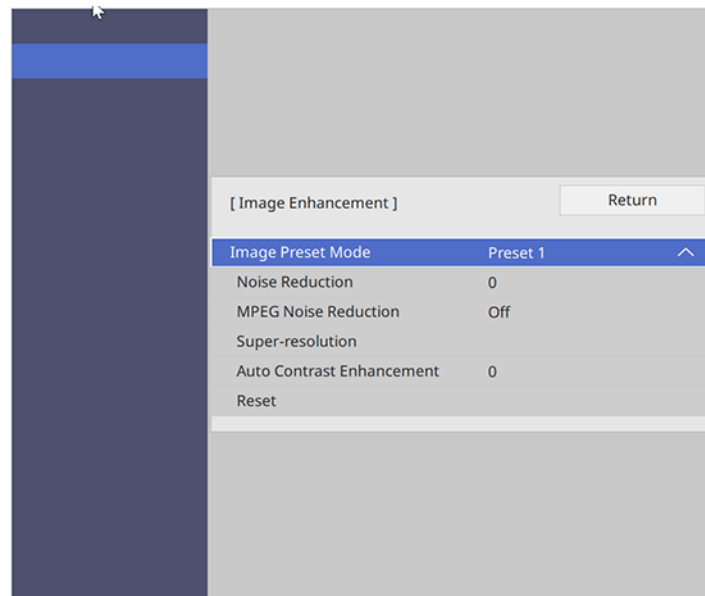

- Adjust the **Noise Reduction** setting to reduce flickering in images.
- Adjust the **MPEG Noise Reduction** setting to reduce the noise or artifacts seen in MPEG video.
- Adjust the **Super-resolution** setting to reduce blurring when projecting low-resolution images.
- Adjust the **Auto Contrast Enhancement** setting to create a clearer and sharper image by automatically adjusting the contrast.

The setting values in the preset option are overwritten as you make changes.

5. Press **Menu** or **Esc** to exit the menus.

To quickly switch between image presets, press the **Image Enh** button on the remote control, select an image preset to use, and press **Enter**.

Parent topic: [Using Advanced Image Adjustment Features](#)

Related references

[Image Quality Settings - Image Menu](#)

Adjusting the Color Convergence (Panel Alignment)

You can use the Panel Alignment feature to manually adjust the color convergence (the alignment of the red and blue colors) in the projected image. You can adjust the pixels horizontally and vertically in increments of eighths within a range of ± 3 pixels. Image quality may decline after performing Panel Alignment.

Note: You can adjust only the red or blue color convergence. Green is the standard color panel and cannot be adjusted.

Note: Allow your projector to warm up for at least 10 to 15 minutes and make sure the image is in focus before you use the Panel Alignment feature. For best results, project an image sized at least 80 inches (203 cm) diagonally in a dark room and on a projection surface that is not colored or textured.

1. Turn on the projector.
2. Press the **Menu** button.
3. Select the **Display** menu and press **Enter**.

Frequently Used Items	Display	
Image	No-signal Screen	Blue
Signal I/O	Startup Screen	On
Installation	Messages	On
Display	Menu Color	White
Operation	Standby Confirmation	On
Management	Panel Alignment	Off
Network	Reset Display Settings	
Memory	Operation	
Initial/All Settings	Direct Power On	Off
	Sleep Mode	On
	Sleep Mode Timer	10 min.
	Standby Mode	Communication On
	Indicators	On
	Trigger Out	Off
	Inv Direction Button	Off
	Reset Operation Settings	
	Management	

4. Select the **Panel Alignment** setting and press **Enter**.

5. Select **On** and press **Enter**.
6. Select the **Select Color** setting and choose one of the following:
 - **R** to adjust the red color convergence.
 - **B** to adjust the blue color convergence.
7. Select the **Pattern Color** setting and press **Enter**.
8. Select **Start Adjustments** and press **Enter**.

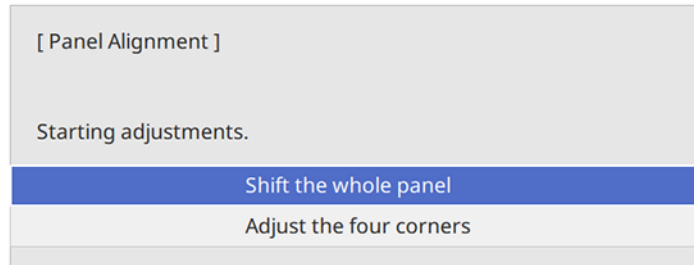

9. Select one of the following:
 - Select **Shift the whole panel** to adjust the whole panel at the same time. (This is not recommended, as usually only certain areas of the panel need to be adjusted.) Go to the next step.
 - Select **Adjust the four corners** to adjust the corners of the panel one at a time. (This is recommended in most cases.) Skip to step 14.
10. Press **Enter**.

You see a screen like this:

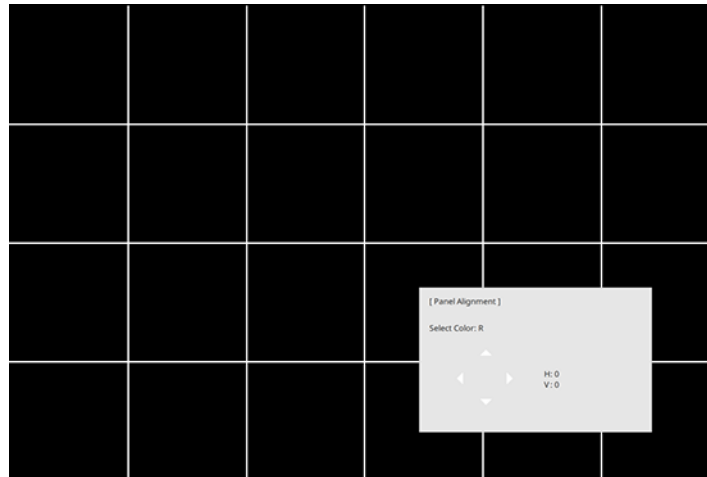

11. Use the arrow buttons on the remote control to adjust the color alignment of the color you selected for the **Select Color** setting.
12. When you are finished adjusting the screen, press **Enter**.

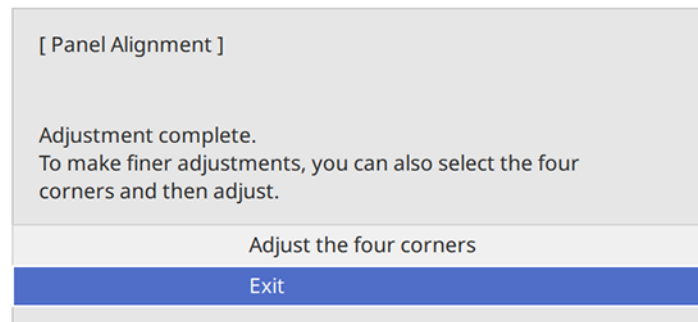

Note: The **Shift the whole panel** option affects the grid lines in the entire screen. To fine-tune your adjustments, continue with the next steps.

13. Select **Adjust the four corners** and press **Enter**. (Otherwise, select **Exit** and press **Enter**.)

14. Use the arrow buttons on the remote control to adjust the color alignment in the corner of the screen highlighted by the orange box.

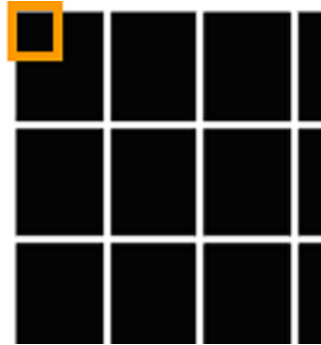

You should not see any red or blue lines after correctly making the adjustments.

15. Press **Enter** to move to the next corner of the screen.
16. When you are finished adjusting each corner of the screen, press **Enter**.

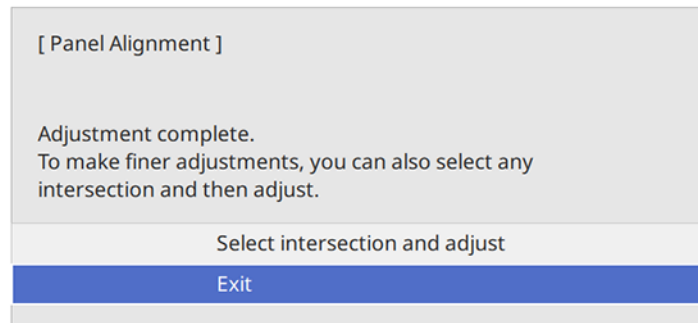

17. Do one of the following:
 - If your projector's panel alignment is now correct, select **Exit** and press **Enter** to return to the Panel Alignment menu.
 - If your projector needs additional panel alignment, select **Select intersection and adjust** and press **Enter**. Use the arrow keys on the remote control to highlight the corner of any misaligned

box on the screen, press **Enter**, make any necessary adjustments and press **Enter** again. Repeat this step as necessary for the other intersections.

Note: To save the adjusted panel alignment setting after exiting, select **Memory > Save Memory** in the Display menu.

Parent topic: [Using Advanced Image Adjustment Features](#)

Adjusting the Color Tone (Color Uniformity)

You can use the Color Uniformity feature to manually adjust the color tone balance in the projected image.

Note: These settings should be set by a professional color calibrator using specialized color calibration tools in a controlled lighting environment.

Note: The color tone may not be uniform even after adjusting the color uniformity.

1. Press the **Menu** button.
2. Select the **Management** menu and press **Enter**.

Frequently Used Items	Management
Image	Lens Lock Off
Signal I/O	Child Lock Off
Installation	Control Panel Lock Off
Display	Color Uniformity
Operation	Log Save Destination USB and Internal Memory
Management	Batch Setup Range
Network	Language  English
Memory	Information
Initial/All Settings	Display Status
	Reset Management Settings
	Network
	Wired LAN Info.
	Network Settings
	Reset Network Settings
	Memory
	Image
	Lens Position

3. Select the **Color Uniformity** setting and press **Enter**.

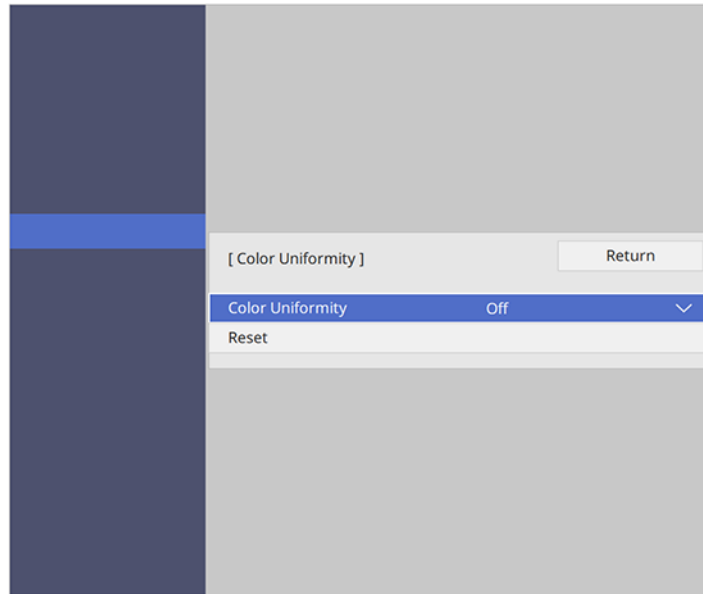

4. Select the **Color Uniformity** setting again and press **Enter**.
5. Select **On** and press **Esc**.
6. Select the **Adjustment Level** setting and press **Enter**.
7. Press the right and left arrow buttons to adjust the level and press **Esc**.

8. Select the **Start Adjustments** setting and press **Enter**.

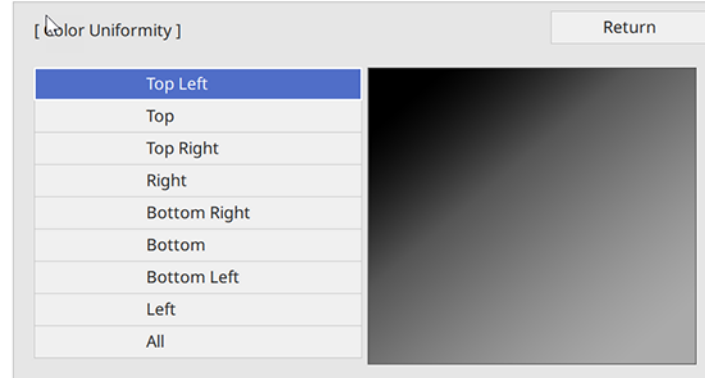

9. Select the area of the screen that you want to adjust and press **Enter**.

Note: Adjust the outer areas first, then select **All** to adjust the entire screen.

10. Select the color you want to adjust. Use the left arrow button to weaken the color tone and the right arrow button to strengthen the color tone.

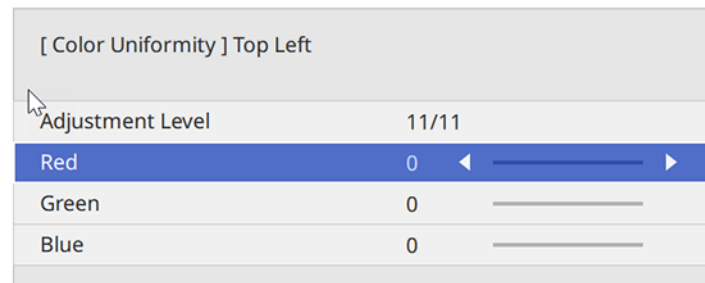

11. Press **Esc** to return to the area selection screen.
12. Repeat these steps for each area you want to adjust and for each adjustment level.
13. Press **Menu** or **Esc** to exit the menus.

Parent topic: [Using Advanced Image Adjustment Features](#)

Saving Settings to Memory and Using Saved Settings

You can save customized settings and select the saved settings whenever you want to use them.

1. Turn on the projector and display an image.
2. Press the **Memory** button on the remote control.

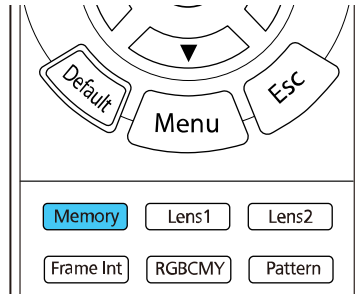

Note: You can also access these settings from the projector's Memory menu.

3. Select one of the following options:

Frequently Used Items	Color Uniformity
Image	Log Save Destination USB and Internal Memory
Signal I/O	Batch Setup Range
Installation	Language 🌐 English
Display	Information
Operation	Display Status
Management	Reset Management Settings
Network	Network
Memory	Wired LAN Info.
Initial/All Settings	Network Settings
	Reset Network Settings
	Memory
	Image
	Lens Position
	Reset Memory Settings
	Initial/All Settings
	Reset All
	Firmware Update

- **Image:** saves your current Image menu settings for each color mode for the projected image (up to 10 memories)
- **Lens Position:** saves your current focus, zoom, and lens shift settings (up to 10 memories); load the saved settings by pressing the **Lens1** or **Lens2** button on the remote control

Note: Some slight adjustments may be needed after switching to a different lens position memory.

Note: To clear all saved memories, select **Reset Memory Settings**.

4. Select one of the following options:

- **Save Memory:** saves your current settings to memory (10 memories with different names are available)

Note: A memory name that has already been used is indicated by a blue mark. Saving over a previously saved memory overwrites the settings with your current settings.

- **Load Memory:** overwrites your current settings with saved settings
- **Erase Memory:** erases the selected memory settings
- **Rename Memory:** renames a saved memory
- **Reset:** resets the name and settings of a saved memory

5. Press **Menu** or **Esc** to exit the menus.

Parent topic: [Adjusting Projector Features](#)

Related references

[Image Quality Memory Settings - Memory Menu](#)

Copying Menu Settings Between Projectors

After you select menu settings for your projector, you can transfer them to another projector of the same model.

Note: Copy the projector's settings before you adjust the projected image using the projector's image adjustment settings.

Caution: If the copy process fails due to a power failure, communication error, or for any other reason, Epson will not be responsible for any repair costs incurred.

The following settings will not transfer between projectors if you set the **Batch Setup Range** setting to **Limited**:

- **EDID** in the Signal I/O menu
- Network menu settings

[Saving Settings to a USB Flash Drive](#)

[Transferring Settings from a USB Flash Drive](#)

[Saving Settings to a Computer](#)

[Transferring Settings from a Computer](#)

Parent topic: [Adjusting Projector Features](#)

Saving Settings to a USB Flash Drive

You can save the projector settings you want to transfer to a USB flash drive.

Note: Use an empty flash drive. If the drive contains other files, the transfer may not complete correctly. The flash drive must use the FAT format and cannot have any security features.

1. Turn off the projector and unplug the power cord from the projector's power inlet.
2. Insert the flash drive into the **USB-A** port.

Note: Connect the flash drive directly to the projector. Do not use a hub or your settings may not be saved correctly.

3. Press and hold the **Esc** button on the control panel or remote control as you connect the power cord to the projector's power inlet.
4. When all of the projector lights turn on, release the **Esc** button.

The lights flash to indicate that settings are transferring to the flash drive. When the lights stop flashing, the power light turns blue and the projector enters standby mode.

Caution: Do not unplug the power cord or remove the flash drive while the lights are flashing. This could damage the projector.

5. Once the projector enters standby mode, remove the flash drive.

Note: If the projector does not enter standby mode and the lights continue flashing, see the link below for a solution.

Parent topic: [Copying Menu Settings Between Projectors](#)

Related references

[Projector Light Status](#)

Transferring Settings from a USB Flash Drive

After saving projector settings to a USB flash drive, you can transfer them to another projector of the same model.

Note: Make sure the USB flash drive contains only a single settings transfer from another projector of the same model. The settings are contained in a file called **pjconfdata.bin**. If the drive contains other files, the transfer may not complete correctly.

Do not adjust image settings on a projector until after you transfer settings to it. Otherwise, you may have to repeat your adjustments.

1. Turn off the projector and unplug the power cord from the projector's power inlet.
2. Insert the flash drive into the **USB-A** port.

Note: Connect the flash drive directly to the projector. Do not use a hub or your settings may not be saved correctly.

3. Press and hold the **Menu** button on the control panel or remote control as you connect the power cord to the projector's power inlet.
4. When all of the projector lights turn on, release the **Menu** button.

The lights flash to indicate that settings are transferring to the projector. When the lights stop flashing, the power light turns blue and the projector enters standby mode.

Caution: Do not unplug the power cord or remove the flash drive while the lights are flashing. This could damage the projector.

5. Once the projector enters standby mode, remove the flash drive.

Note: If the projector does not enter standby mode and the lights continue flashing, see the link below for a solution.

Parent topic: [Copying Menu Settings Between Projectors](#)

Related references

[Projector Light Status](#)

Saving Settings to a Computer

You can save the projector settings you want to transfer to a computer.

Your computer must be running one of the following operating systems:

- Windows 8.x
- Windows 10
- macOS 10.13.x
- macOS 10.14.x
- macOS 10.15.x
- macOS 11.x

1. Turn off the projector and unplug the power cord from the projector's power inlet.
2. Connect a USB cable to your projector's **Service** port.
3. Connect the other end to any available USB port on your computer.
4. Press and hold the **Esc** button on the control panel or remote control as you connect the power cord to the projector's power inlet.
5. When all of the projector lights turn on, release the **Esc** button.
The projector shows up as a removable disk on your computer.
6. Open the removable disk and copy the **pjconfdata.bin** file to your computer.
7. Once the file has copied, do one of the following:
 - **Windows:** Open the **My Computer**, **Computer**, **Windows Explorer**, or **File Explorer** utility. Right-click the name of your projector (listed as a removable disk) and select **Eject**.
 - **Mac:** Drag the removable disk icon for your projector from the desktop into the trash.The projector turns off when you disconnect the USB cable.

Note: If the projector does not turn off and the lights continue flashing, see the link below for a solution.

Parent topic: [Copying Menu Settings Between Projectors](#)

Related references

[Projector Light Status](#)

Transferring Settings from a Computer

After saving projector settings to a computer, you can transfer them to another projector of the same model.

Your computer must be running one of the following operating systems:

- Windows 8.x
- Windows 10
- macOS 10.13.x
- macOS 10.14.x
- macOS 10.15.x
- macOS 11.x

Do not adjust image settings on a projector until after you transfer settings to it. Otherwise, you may have to repeat your adjustments.

1. Turn off the projector and unplug the power cord from the projector's power inlet.
2. Connect a USB cable to your projector's **Service** port.
3. Connect the other end to any available USB port on your computer.
4. Press and hold the **Menu** button on the control panel or remote control as you connect the power cord to the projector's power inlet.
5. When all of the projector lights turn on, release the **Menu** button.
The projector shows up as a removable disk on your computer.
6. Copy the **pjconfdata.bin** file from your computer to the removable disk.

Note: Do not copy any other files to the removable disk.

7. Once the file has copied, do one of the following:
 - **Windows:** Open the **My Computer**, **Computer**, **Windows Explorer**, or **File Explorer** utility. Right-click the name of your projector (listed as a removable disk) and select **Eject**.
 - **Mac:** Drag the removable disk icon for your projector from the desktop into the trash.

All the lights start flashing to indicate that the projector's settings are being updated. When the lights stop flashing, remove the USB cable from the projector. The projector enters standby mode.

Caution: Do not unplug the power cord while the lights are flashing. This could damage the projector.

Note: If the projector does not turn off and the lights continue flashing, see the link below for a solution.

Parent topic: [Copying Menu Settings Between Projectors](#)

Related references

[Projector Light Status](#)

Adjusting the Menu Settings

Follow the instructions in these sections to access the projector menu system and change projector settings.

[Using the Projector's Menus](#)

[Image Quality Settings - Image Menu](#)

[Input Signal Settings - Signal I/O Menu](#)

[Installation Settings - Installation Menu](#)

[Display Settings - Display Menu](#)

[Feature Settings - Operation Menu](#)

[Administration Settings - Management Menu](#)

[Network Settings - Network Menu](#)

[Image Quality Memory Settings - Memory Menu](#)

[Initial Settings and Reset Options - Initial/All Settings Menu](#)

Using the Projector's Menus

You can use the projector's menus to adjust the settings that control how your projector works. The projector displays the menus on the screen.

1. Press the **Menu** button on the control panel or remote control.

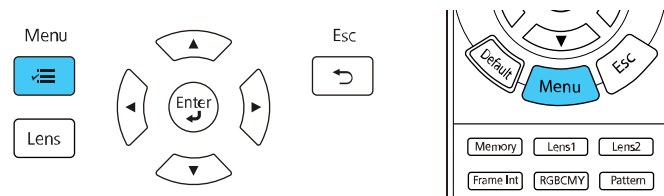

You see the menu screen.

Frequently Used Items	Image	
Image	Color Mode	Presentation
Signal I/O	Brightness	50
Installation	Contrast	50
Display	Color Saturation	50
Operation	Tint	50
Management	Sharpness	
Network	White Balance	
Memory	Frame Interpolation	Off
Initial/All Settings	Light Output	100 %
	Dynamic Contrast	Off
	Deinterlacing	Off
	Image Enhancement	
	Scene Adaptive Gamma	5
	Gamma	0
	RGBCMY	
	Reset to Defaults	
	Source	Computer1
	Aspect	Auto

2. Press the up or down arrow button to move through the menus listed on the left. The settings for each menu are displayed on the right.

Note: The available settings depend on the current input source, resolution, or other menu settings.

3. To change settings in the displayed menu, press **Enter**.
4. Press the up or down arrow button to move through the settings.
5. To return all the menu settings to their default values, select the **Initial/All Settings** menu and select **Reset All**.
6. When you finish changing settings on a menu, press **Esc**.
7. Press **Menu** or **Esc** to exit the menus.

Note: The  icon indicates that a setting contains sub-settings.

Parent topic: [Adjusting the Menu Settings](#)

Image Quality Settings - Image Menu

Settings on the Image menu let you adjust the quality of your image for the input source you are currently using. The available settings depend on the currently selected color mode and input source.

Frequently Used Items	Image	
Image	Color Mode	Presentation
Signal I/O	Brightness	50
Installation	Contrast	50
Display	Color Saturation	50
Operation	Tint	50
Management	Sharpness	
	White Balance	
Network	Frame Interpolation	Off
Memory	Light Output	100 %
Initial/All Settings	Dynamic Contrast	Off
	Deinterlacing	Off
	Image Enhancement	
	Scene Adaptive Gamma	5
	Gamma	0
	RGBCMY	
	Reset to Defaults	
	Source	Computer1
	Aspect	Auto

Color Mode Settings

Setting	Options	Description
Color Mode	See the list of available Color Modes	Adjusts the vividness of image colors for various image types and environments
Brightness	Varying levels available	Lightens or darkens the overall image
Contrast	Varying levels available	Adjusts the difference between light and dark areas of the image
Color Saturation	Varying levels available	Adjusts the intensity of the image colors

Setting	Options	Description
Tint	Varying levels available	Adjusts the balance of green to magenta tones in the image
Sharpness	Varying levels available	Adjusts the sharpness or softness of image details
White Balance	Color Temp. G-M Correction Custom Grayscale	Sets the overall color tone of the image Color Temp.: sets the color temperature according to the selected color mode; lower values tint the image red, and higher values tint the image blue G-M Correction: makes fine adjustments to the color tone; higher values tint the image green and lower values tint the image red Custom: adjusts the individual RGB components of the offset and gain Grayscale: adjusts the red, green, blue, and brightness for the selected adjustment level
Frame Interpolation	Off Low Normal High	Adjusts the smoothness of image movement (only available when Image Processing is set to Fine in the Signal I/O menu and 4K 100/120Hz signals are not being projected)
Light Output	50% (ECO) to 100% (Normal)	Sets the brightness for the light source
Dynamic Contrast	Off Normal High Speed	Adjusts the projected luminance based on the image brightness

Setting	Options	Description
Deinterlacing	Off Video Film/Auto	Sets whether to convert interlaced-to-progressive signals for certain video image types (only available when Image Processing is set to Fine in the Signal I/O menu) Off : for fast-moving video images Video : for most video images Film/Auto : for movies, computer graphics, and animation

Setting	Options	Description
Image Enhancement	Image Preset Mode	Selects preset Image Enhancement settings
	Noise Reduction	Reduces flickering in analog images (only available when Image Processing is set to Fine in the Signal I/O menu and 4K 100/120Hz signals are not being projected)
	MPEG Noise Reduction	Reduces the noise or static in MPEG video (only available when Image Processing is set to Fine in the Signal I/O menu and 4K 100/120Hz signals are not being projected)
	Super-resolution	Sharpens blurred images when projecting low-resolution images Fine Line Adjust: enhances the contrast and outlines of complicated images Soft Focus Detail: enhances the contrast and outlines of smooth backgrounds
	Auto Contrast Enhancement	Automatically adjusts the contrast of the projected image to create a clearer and sharper image
	Reset	Resets all settings in the Image Enhancement menu
Scene Adaptive Gamma	Varying levels available	Adjusts the coloring and obtains a more vivid image depending on the scene. Select a larger number to enhance contrast.
Gamma	-2 to 2 Custom	Adjusts the colors by selecting one of the gamma correction values or referring to a gamma graph

Setting	Options	Description
RGBCMY	Varying levels available	Adjusts the hue, saturation, and brightness for each color
Reset to Defaults	—	Resets all settings for the Color Mode currently selected

Note: The **Brightness** setting does not affect laser brightness. To change the laser brightness mode, use the **Light Output** setting.

Input Source Settings

To change settings for an input source, make sure the source is connected and select that source.

Setting	Options	Description
Source	—	Displays the current input source selected
Aspect	See the list of available aspect ratios	Sets the aspect ratio (width-to-height ratio)
Reset to Defaults	—	Resets all settings for the currently selected input source

Note: Select **Reset Image Settings** to reset all settings on the Image menu to their default values.

Parent topic: [Adjusting the Menu Settings](#)

Related references

[Input Signal Settings - Signal I/O Menu](#)

[Available Image Aspect Ratios](#)

[Available Color Modes](#)

Input Signal Settings - Signal I/O Menu

Normally the projector detects and optimizes the input signal settings automatically. If you need to customize the settings, you can use the Signal I/O menu. The available settings depend on the currently selected input source.

Frequently Used Items	Signal I/O	
Image	Source	Computer1
Signal I/O	Overscan	Auto
Installation	Color Space	Auto
Display	Dynamic Range	
Operation	Image Processing	Fine
Management	HDMI IN EQ Level	
Network	Reset to Defaults	
Memory	EDID	
Initial/All Settings	HDMI Link	
	Reset Signal I/O Settings	
	Installation	
	Test Pattern	
	Projection	Front/Ceiling
	Geometry Correction	Point Correction
	Blanking	
	High Altitude Mode	Off
	Reset Installation Settings	

To change settings for an input source, make sure the source is connected and select that source.

Setting	Options	Description
Source	—	Displays settings selected for the current input source

Setting	Options	Description
Signal Format	Video Range	<p>Sets the video range to match the setting of an input source connected to the HDMI ports</p> <p>Auto: detects the video range automatically</p> <p>Limited (16–235): for brightness range 16–235</p> <p>Full (0–255): for brightness range 0–255</p>
Overscan	Auto Off 4% 8%	<p>Changes the projected image ratio to make the edges visible by a selectable percentage or automatically when projecting a component signal</p>
Color Space	Auto BT.709 BT.2020	<p>Sets the conversion system for the color space (set to Auto for most cases)</p>
Dynamic Range	Dynamic Range Signal Status HDR10/HDR10+ Setting HLG Setting	<p>Dynamic Range: changes the range of dark and bright areas in the image (set to Auto for most cases)</p> <p>Signal Status: displays the detected input signal</p> <p>HDR10/HDR10+ Setting: adjusts the PQ curve of the dynamic range (available when Dynamic Range or Signal Status is set to HDR10 or HDR10+)</p> <p>HLG Setting: adjusts the HLG curve of the dynamic range (available when Dynamic Range or Signal Status is set to HLG)</p>

Setting	Options	Description
Image Processing	Fine Fast	Improves the response speed for images projected at high speed Fine: improves the response speed for images (Frame Interpolation in the Image menu must be turned off) Fast: disables Frame Interpolation , Noise Reduction , and MPEG Noise Reduction settings
HDMI IN EQ Level	HDMI1 HDMI2	Adjusts the HDMI input signal level if there is image static or noise, depending on the device connected to the HDMI port Auto: this is the recommended setting for most cases Low: select if there is noise when using a short HDMI cable Medium: select if the other settings do not reduce the noise High: select if there is noise when using a long HDMI cable
Reset to Defaults	—	Resets all settings for the current input source
EDID	EDID (HDMI1) EDID (HDMI2)	Describes the display capabilities of your projector (if images are not displayed correctly, you may be able to display them by changing this setting) EDID Mode: change this setting as necessary according to the resolution of the image HDR10+: set to Off to correctly display images when the current input source does not support HDR10+

Setting	Options	Description
HDMI Link	Device Connections HDMI Link Power On Link Power Off Link	<p>Adjusts the HDMI Link options that allow the projector or remote to control HDMI-connected devices that support the CEC standard</p> <p>Device Connections: lists the devices connected to the HDMI1 and HDMI2 ports when HDMI Link is enabled</p> <p>HDMI Link: enables or disables the HDMI Link feature</p> <p>Power On Link: controls what happens when you turn on the projector or a linked device</p> <ul style="list-style-type: none"> • Bidirectional: automatically turns on the connected device when you turn on the projector, and vice versa • Device -> PJ: automatically turns on the projector when you turn on the connected device • PJ -> Device: automatically turns on the connected device when you turn on the projector <p>Power Off Link: controls whether linked devices are turned off when the projector is turned off</p>
Reset Signal I/O Settings		Resets all settings on the Signal I/O menu to their default values

Parent topic: [Adjusting the Menu Settings](#)

Related references

[Image Quality Settings - Image Menu](#)

Installation Settings - Installation Menu

Settings on the Installation menu let you set up your projector for your installation environment. The available settings depend on the currently selected input source and other settings.

Frequently Used Items	Installation	
Image	Test Pattern	
Signal I/O	Projection	Front/Ceiling
Installation	Geometry Correction	Point Correction
Display	Blanking	
Operation	High Altitude Mode	Off
Management	Reset Installation Settings	
Network	Display	
Memory	No-signal Screen	Blue
Initial/All Settings	Startup Screen	On
	Messages	On
	Menu Color	White
	Standby Confirmation	On
	Panel Alignment	Off
	Reset Display Settings	
	Operation	
	Direct Power On	Off
	Sleep Mode	On

Setting	Options	Description
Test Pattern	Display Position Color Isolation: R Color Isolation: G Color Isolation: B	<p>Displays a test pattern to assist in focusing and zooming the image and correcting image shape</p> <p>The color isolation options let you display the selected color component of the projected image. These settings should be set by a professional color calibrator using specialized color calibration tools in a controlled lighting environment.</p>

Setting	Options	Description
Projection	Front Front/Ceiling Rear Rear/Ceiling	Selects the way the projector faces the screen so the image is oriented correctly
Geometry Correction	H/V-Keystone Quick Corner Point Correction	Adjusts image shape to rectangular (horizontally and vertically) H/V Keystone: lets you manually correct horizontal and vertical sides Quick Corner: select to correct image shape and alignment using an on-screen display Point Correction: select to divide the projected image into a grid and correct distortion by moving a selected point
Blanking	Top Bottom Left Right	Hides the edges of the screen if there is noise from the input signal
High Altitude Mode	On Off	Regulates the projector's operating temperature at altitudes above 4921 feet (1500 m) Note: The cooling fans inside the projector run faster and may sound louder when this setting is enabled; this is normal.
Reset Installation Settings	—	Resets all settings on the Installation menu to their default values

Parent topic: [Adjusting the Menu Settings](#)

Display Settings - Display Menu

Settings on the Display menu let you customize various projector display features. The available settings depend on the currently selected input source and other settings.

Frequently Used Items	Display	
Image	No-signal Screen	Blue
Signal I/O	Startup Screen	On
Installation	Messages	On
Display	Menu Color	White
Operation	Standby Confirmation	On
Management	Panel Alignment	Off
Network	Reset Display Settings	
Memory	Operation	
Initial/All Settings	Direct Power On	Off
	Sleep Mode	On
	Sleep Mode Timer	10 min.
	Standby Mode	Communication On
	Indicators	On
	Trigger Out	Off
	Inv Direction Button	Off
	Reset Operation Settings	
	Management	

Setting	Options	Description
No-signal Screen	Black Blue Logo	Select the screen color or logo to display when no input signal is detected
Startup Screen	On Off	Controls whether a logo is displayed when the projector starts up
Messages	On Off	Controls whether projector status and error messages are displayed on the projected image

Setting	Options	Description
Menu Color	Black White	Sets the color theme of the projector menus
Standby Confirmation	On Off	Displays a confirmation screen before turning off the projector
Panel Alignment	On Off	<p>Corrects color misalignment in the projected image</p> <p>Select Color: select the color to correct (R or B)</p> <p>Pattern Color: select the pattern used for correction</p> <p>Start Adjustments: starts panel alignment</p> <p>Memory: saves, loads, renames, or erases panel alignment settings</p> <p>Reset: resets all panel alignment settings to their defaults</p>
Reset Display Settings	—	Resets all settings on the Display menu to their default values

Parent topic: [Adjusting the Menu Settings](#)

Feature Settings - Operation Menu

Settings on the Operation menu let you customize various projector features that control its operation. The available settings depend on the currently selected input source and other settings.

Frequently Used Items	Operation	
Image	Direct Power On	Off
Signal I/O	Sleep Mode	On ^
Installation	Sleep Mode Timer	10 min.
Display	Standby Mode	Communication On
Operation	Indicators	On
Management	Trigger Out	Off
Network	Inv Direction Button	Off
Memory	Reset Operation Settings	
Initial/All Settings	Management	
	Lens Lock	Off
	Child Lock	Off
	Control Panel Lock	Off
	Color Uniformity	
	Log Save Destination	USB and Internal Memory
	Batch Setup Range	
	Language 🌐	English
	Information	

Setting	Options	Description
Direct Power On	On Off	Controls whether the projector automatically turns on when you plug it in
Sleep Mode	On Off	Automatically turns off the projector after an interval of inactivity Sleep Mode Timer: sets the time from 1 to 30 minutes before the projector automatically turns off

Setting	Options	Description
Standby Mode	Communication On Communication Off	Enable this setting to allow monitoring and control of the projector over a network when the projector is in standby mode
Indicators	On Off	Enables or disables the status indicator lights on the projector
Trigger Out	Off Power Anamorphic Wide	Outputs a DC 12V signal at 200 mA maximum from the Trigger Out port whenever the projector is turned on (if you select Anamorphic Wide , voltage is only output from the Trigger Out port when the Aspect setting is set to Anamorphic Wide or Horiz.Squeeze)
Inv Direction Button	On Off	Inverts the direction of the arrow buttons on the control panel to match the projector's installation position
Reset Operation Settings	—	Reset all settings on the Operation menu to their default values

Parent topic: [Adjusting the Menu Settings](#)

Related references

[Image Quality Settings - Image Menu](#)

Administration Settings - Management Menu

Settings on the Management menu let you customize various projector administrative features.

Frequently Used Items	Management	
Image	Lens Lock	Off
Signal I/O	Child Lock	Off
Installation	Control Panel Lock	Off
Display	Color Uniformity	
Operation	Log Save Destination	USB and Internal Memory
Management	Batch Setup Range	
Network	Language 	English
Memory	Information	
Initial/All Settings	Display Status	
	Reset Management Settings	
	Network	
	Wired LAN Info.	
	Network Settings	
	Reset Network Settings	
	Memory	
	Image	
	Lens Position	

Setting	Options	Description
Lens Lock	On Off	Locks the focus, zoom, and lens shift settings
Child Lock	On Off	Locks the power button on the projector's control panel (only displayed when the Control Panel Lock setting is set to Except for Power or Off)

Setting	Options	Description
Control Panel Lock	Full Lock Except for Power Off	Controls projector button locking to secure the projector Full Lock: locks all buttons Except for Power: locks all buttons except the power button Off: no buttons locked
Color Uniformity	On Off	Adjusts the color tone balance Adjustment Level: sets the adjustment level Start Adjustments: adjusts the red, green, and blue color tones individually for the selected area Reset: resets all Color Uniformity adjustment values to their defaults
Log Save Destination	Internal Memory USB and Internal Memory	Selects where you want to save projector error and operation log files
Batch Setup Range	All Limited	Selects which projector menu settings to copy using the batch setup feature; select All to copy all the settings, or select Limited to copy all settings except for the following: <ul style="list-style-type: none"> • EDID setting in the Signal I/O menu • Network menu settings
Language	Various languages available	Selects the language for projector menu and message displays

Setting	Options	Description
Information	Operation Hours Light Source Hours Source Input Signal Resolution Refresh Rate Sync Info Status Serial Number Version	<p>Displays information about the projector and current input signal; the displayed items vary depending on the current input source</p> <p>The Version option displays version numbers for the projector and other components</p>
Display Status	System Version Network Wired Input Signal	Displays status information for the projector
Reset Management Settings	—	Resets all settings on the Management menu to their default values except for the Language setting

Parent topic: [Adjusting the Menu Settings](#)

Network Settings - Network Menu

Settings on the Network menu let you view network information and set up the projector for control over a network.

Frequently Used Items	Control Panel Lock	Off
Image	Color Uniformity	
Signal I/O	Log Save Destination	USB and Internal Memory
Installation	Batch Setup Range	
Display	Language 	English
Operation	Information	
Management	Display Status	
	Reset Management Settings	
Network	Network	
Memory	Wired LAN Info.	
Initial/All Settings	Network Settings	
	Reset Network Settings	
	Memory	
	Image	
	Lens Position	
	Reset Memory Settings	
	Initial/All Settings	
	Reset All	

Setting	Options	Description
Wired LAN Info.	—	Displays wired network status and details for the following: <ul style="list-style-type: none"> • Projector Name • DHCP • IP Address • Subnet Mask • Gateway Address • MAC Address

Setting	Options	Description
Network Settings	Projector Name Wired LAN Projector Control	Configures your network settings Projector Name: enters a name to identify the projector over the network Wired LAN: configures IP settings Projector Control: selects settings for controlling the projector over a network (PJLink, AMX Device Discovery, Control4 SDDP)
Reset Network Settings	—	Resets all settings on the Network menu to their default values

Parent topic: [Adjusting the Menu Settings](#)

Related references

[Projector Control Settings](#)

Image Quality Memory Settings - Memory Menu

Settings on the Memory menu let you save and load image quality settings in the projector's memory.

Frequently Used Items	Color Uniformity	
Image	Log Save Destination	USB and Internal Memory
Signal I/O	Batch Setup Range	
Installation	Language 	English
Display	Information	
Operation	Display Status	
Management	Reset Management Settings	
Network	Network	
	Wired LAN Info.	
Memory	Network Settings	
Initial/All Settings	Reset Network Settings	
	Memory	
	Image	
	Lens Position	
	Reset Memory Settings	
	Initial/All Settings	
	Reset All	
	Firmware Update	

Setting	Options	Description
Image	Save Memory Load Memory Rename Memory Erase Memory Reset	Saves, loads, renames, erases, or resets the current image settings
Lens Position	Save Memory Load Memory Rename Memory Erase Memory Reset	Saves, loads, renames, erases, or resets the focus, zoom, and lens shift adjustments

Setting	Options	Description
Reset Memory Settings	—	Resets all memory settings to their defaults

Parent topic: [Adjusting the Menu Settings](#)

Initial Settings and Reset Options - Initial/All Settings Menu

Settings on the Initial/All Settings menu let you reset most projector settings to their default values. You can also update the projector firmware from this menu.

Frequently Used Items	Color Uniformity	
Image	Log Save Destination	USB and Internal Memory
Signal I/O	Batch Setup Range	
Installation	Language 	English
Display	Information	
Operation	Display Status	
Management	Reset Management Settings	
Network	Network	
Memory	Wired LAN Info.	
	Network Settings	
Initial/All Settings	Reset Network Settings	
	Memory	
	Image	
	Lens Position	
	Reset Memory Settings	
	Initial/All Settings	
	Reset All	
	Firmware Update	

When you select the **Reset All** option, you see this screen:

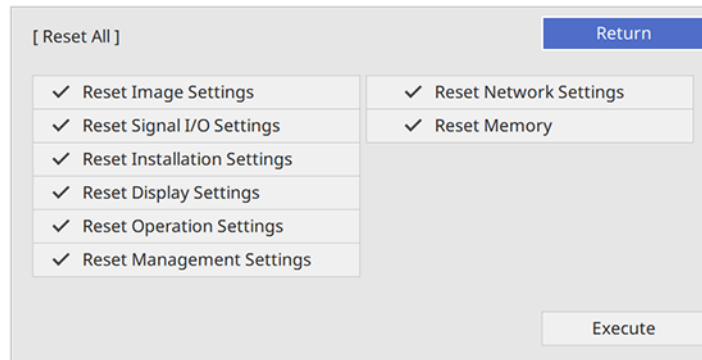

Checkmarks appear next to the menu settings that are selected to be reset. If you do not want to reset settings in some menus, deselect them. When you are ready, select **Execute** and press **Enter**.

Note: You cannot reset the Language setting using the **Reset All** option.

Select **Firmware Update** to enter firmware update mode using the USB-A or Service port.

Note: See the link below for details on updating the projector's firmware.

Parent topic: [Adjusting the Menu Settings](#)

Related concepts

[Updating the Firmware](#)

Maintaining and Transporting the Projector

Follow the instructions in these sections to maintain your projector and transport it from place to place.

[Projector Maintenance](#)

[Replacing the Remote Control Batteries](#)

[Updating the Firmware](#)

[Transporting the Projector](#)

Projector Maintenance

Your projector needs little maintenance to keep working at its best.

You may need to clean the lens periodically, and clean the air filter and air vents to prevent the projector from overheating due to blocked ventilation.

The only parts you should replace are the air filter and remote control batteries. If any other part needs replacing, contact Epson or an authorized Epson servicer.

This projector uses a sealed laser light source which does not need servicing and cannot be replaced.

Warning: Before cleaning any part of the projector, turn it off, unplug the power cord, and let it cool down. Never open any cover on the projector, except as specifically explained in this manual. Dangerous electrical voltages in the projector can injure you severely.

Warning: Do not try to service this product yourself, except as specifically explained in this manual. Refer all other servicing to Epson qualified servicers.

[Cleaning the Lens](#)

[Cleaning the Projector Case](#)

[Air Filter and Vent Maintenance](#)

Parent topic: [Maintaining and Transporting the Projector](#)

Related references

[Optional Equipment and Replacement Parts](#)

Cleaning the Lens

Clean the projector's lens periodically, or whenever you notice dust or smudges on the surface. Make sure you unplug the projector before cleaning the lens.

- To remove dust or smudges, gently move the shutter to the side and wipe the lens with lens-cleaning paper or a soft, dry lens-cleaning cloth. After cleaning, close the shutter.
- To remove stubborn smudges, moisten a soft, lint-free cloth with lens cleaner and gently wipe the lens. Do not spray any liquid directly on the lens.

Warning: Do not use a lens cleaner that contains flammable gas. The high heat generated by the projector may cause a fire. Use a vacuum cleaner or a hand-held air blower to remove any dust and lint on the lens.

Caution: Do not wipe the lens immediately after turning off the light source; otherwise, it could be damaged. Do not use glass cleaner or any harsh materials to clean the lens and do not subject the lens to any impacts; you may damage it. Do not use canned air, or the gases may leave a residue. Avoid touching the lens with your bare hands to prevent fingerprints on or damage to the lens surface.

Parent topic: [Projector Maintenance](#)

Cleaning the Projector Case

Before cleaning the projector case, turn off the projector and unplug the power cord.

- To remove dust or dirt, use a soft, dry, lint-free cloth.
- To remove stubborn dirt, use a soft cloth moistened with water and mild soap. Do not spray liquid directly on the projector.

Caution: Do not use wax, alcohol, benzine, paint thinner, or other chemicals to clean the projector case. These can damage the case. Do not use canned air, or the gases may leave a flammable residue.

Parent topic: [Projector Maintenance](#)

Air Filter and Vent Maintenance

Regular filter maintenance is important to maintaining your projector. Your Epson projector is designed with an easily accessible, user-replaceable filter to protect your projector and make regular maintenance simple. Filter maintenance intervals will depend on the environment.

If regular maintenance is not performed, your Epson projector will notify you when the temperature inside the projector has reached a high level. Do not wait until this warning appears to maintain your projector filter as prolonged exposure to high temperatures may reduce the life of your projector or laser.

Damage due to the failure to properly maintain the projector or its filter may not be covered by the projector's Limited Warranty.

[Cleaning the Air Filter](#)

[Replacing the Air Filter](#)

Parent topic: [Projector Maintenance](#)

Related references

[Optional Equipment and Replacement Parts](#)

Cleaning the Air Filter

You need to clean the projector's air filter in the following situations:

- The filter or vents get dusty.
- You see a message telling you to clean it.

Note: It is recommended that you clean the air filter every 5,000 hours. Clean it more often if the projector is in a dusty environment.

1. Turn off the projector and unplug the power cord.
2. Carefully remove the dust from the air filter cover with a vacuum or brush.

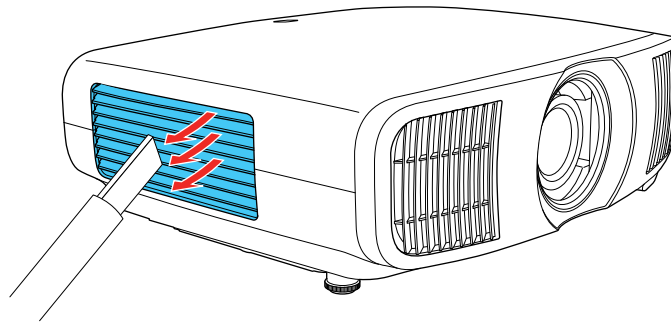

Note: Canned or compressed air is not recommended as it can blow dust into the projector.

3. Loosen the screws and remove the air filter cover.

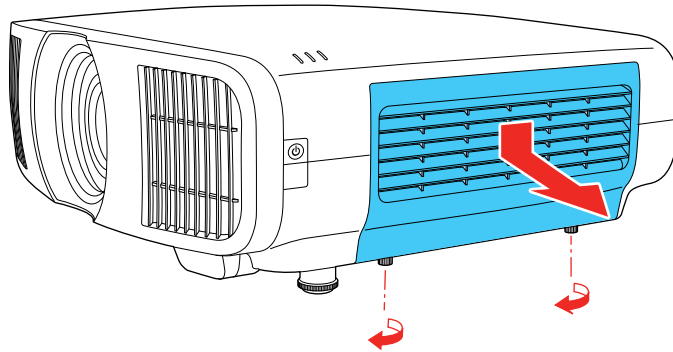

4. Raise the stopper.

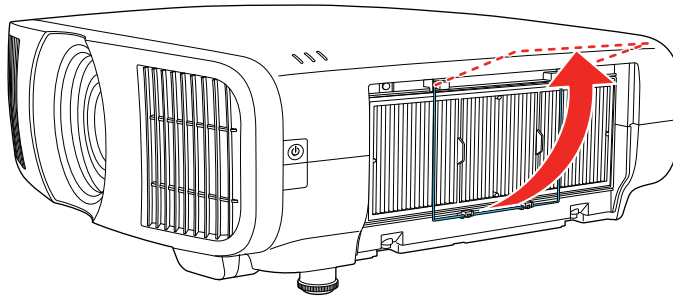

5. Pull the air filter out of the projector.

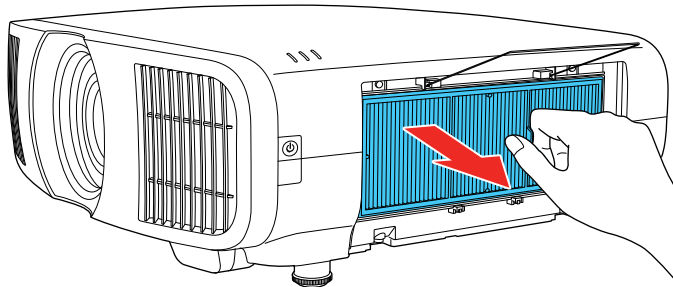

6. Tap each side of the air filter 4 to 5 times to shake off any excess dust.

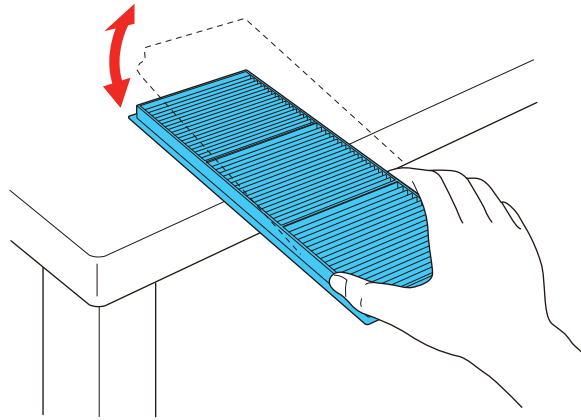

Caution: Do not use excessive force when tapping the air filter, or it may crack and become unusable. Do not rinse the air filter in water, or use any detergent or solvent to clean it. Do not use canned air; the gases may leave a residue, or push dust and debris into the projector's optics or other sensitive areas.

7. Vacuum the front of the air filter (the side with the tabs) to remove any remaining dust.

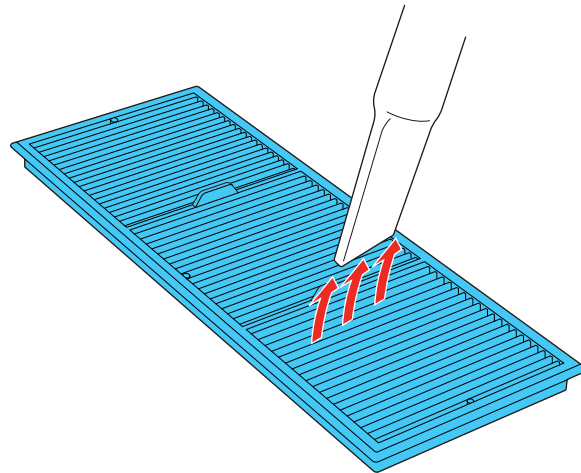

Note: If dust is difficult to remove or the air filter is damaged, replace the air filter.

8. Place the air filter back in the projector as shown.

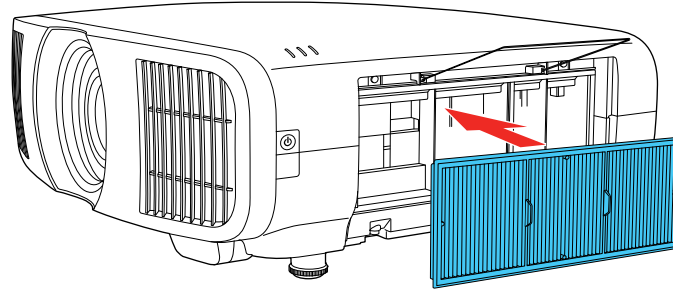

9. Lower the stopper and press until it clicks into place.

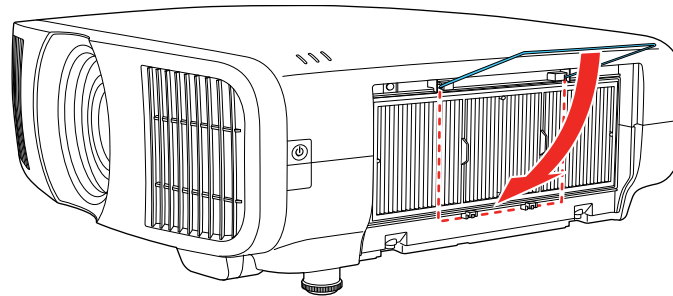

10. Replace the air filter cover and tighten the screws as shown.

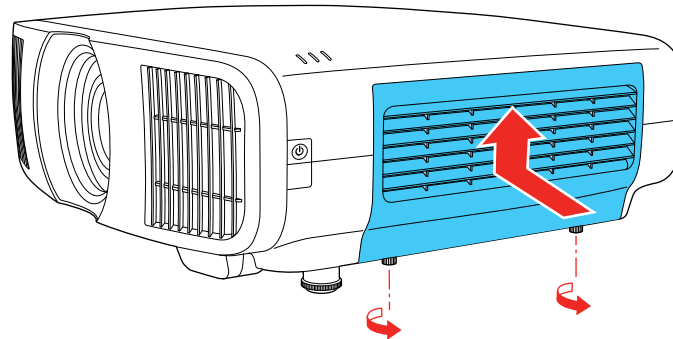

Parent topic: [Air Filter and Vent Maintenance](#)

Related tasks

[Replacing the Air Filter](#)

Replacing the Air Filter

You need to replace the air filter in the following situations:

- After cleaning the air filter, you see a message telling you to clean or replace it
- The air filter is torn or damaged

You can replace the air filter while the projector is mounted to the ceiling or placed on a table.

1. Turn off the projector and unplug the power cord.
2. Loosen the screws and remove the air filter cover.

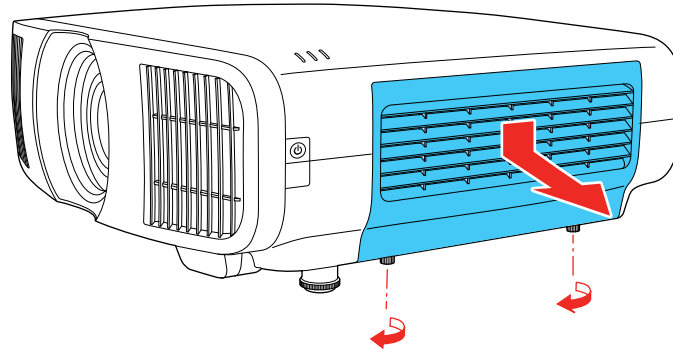

3. Raise the stopper.

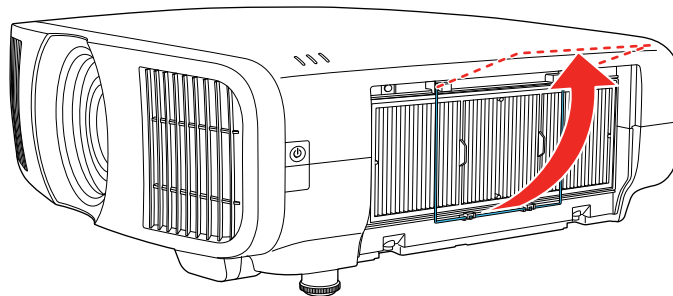

4. Pull the air filter out of the projector.

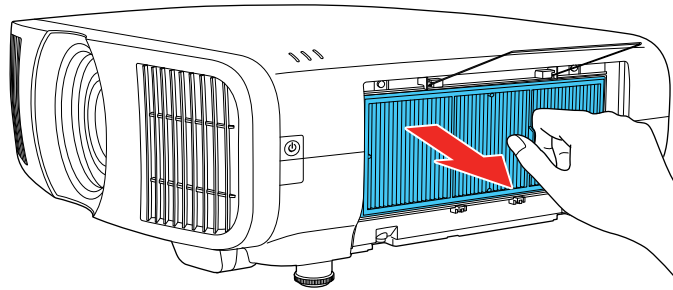

Note: Air filters contain polypropylene. Dispose of used air filters according to local regulations.

5. Place the new air filter in the projector as shown.

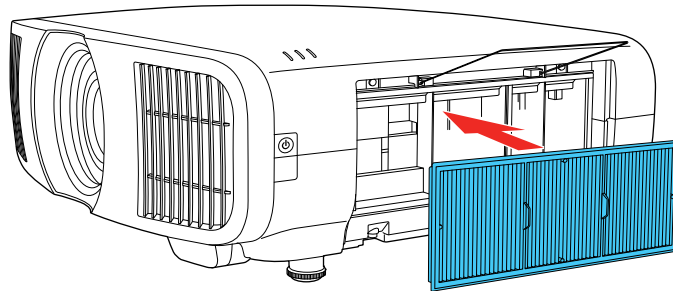

6. Lower the stopper and press until it clicks into place.

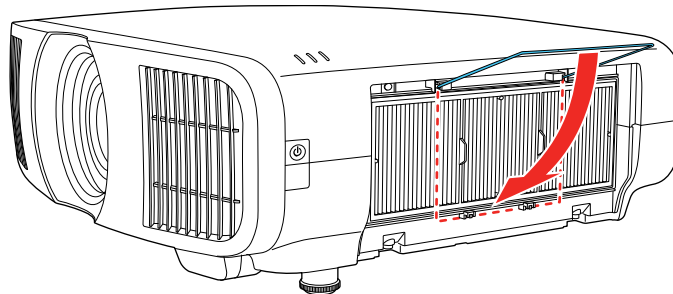

7. Replace the air filter cover and tighten the screws as shown.

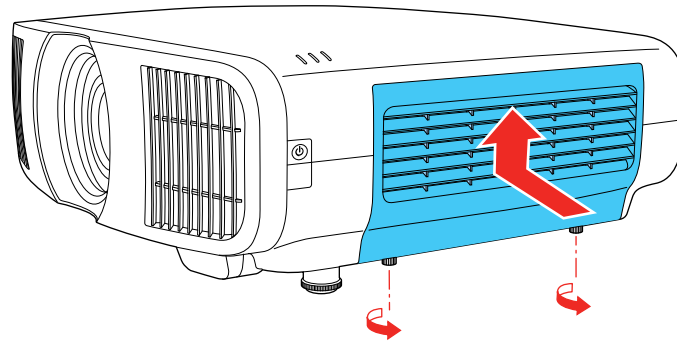

Parent topic: [Air Filter and Vent Maintenance](#)

Related references

[Optional Equipment and Replacement Parts](#)

Replacing the Remote Control Batteries

The remote control uses two AA manganese or alkaline batteries. Replace the batteries as soon as they run out.

Caution: Use only the type of batteries specified in this manual. Do not install batteries of different types, or mix new and old batteries.

1. Remove the battery cover as shown.

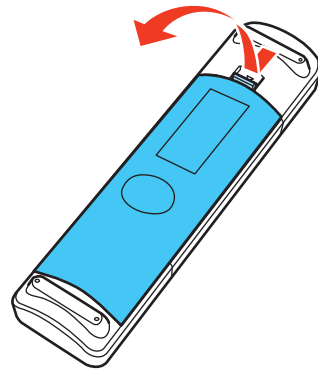

2. Remove the old batteries.

Warning: If the battery fluid has leaked, wipe it away with a soft cloth and avoid getting the fluid on your hands. If it gets on your hands, wash them immediately to avoid injury.

3. Insert the batteries with the + and – ends facing as shown.

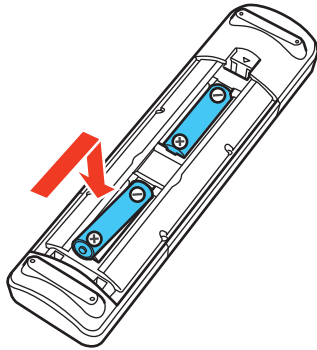

Warning: Make sure the batteries are inserted in the correct positions. If the batteries are not inserted correctly, they could explode or leak, causing a fire, injury, or damage to the product.

4. Replace the battery cover and press it down until it clicks into place.

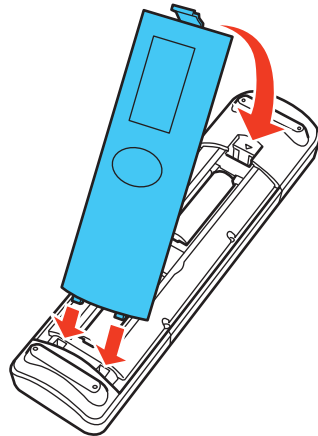

Warning: Dispose of used batteries according to local regulations. Do not expose batteries to heat or flame. Keep batteries out of the reach of children; they are choking hazards and are very dangerous if swallowed.

Parent topic: [Maintaining and Transporting the Projector](#)

Updating the Firmware

You can update the projector's firmware using a USB storage device or a computer and a USB cable.

If a firmware update is available for your product, you can select the **Firmware Update** option in the projector's Initial/All Settings menu. The projector enters firmware update mode and is ready to perform a firmware update. If a firmware update file is not found, the projector enters standby mode.

You can download your firmware update file from your product's support page or use the Epson Projector Management software to check for firmware updates for your product.

[Updating Projector Firmware Using a USB Storage Device](#)

[Updating Projector Firmware Using a Computer and USB Cable](#)

Parent topic: [Maintaining and Transporting the Projector](#)

Updating Projector Firmware Using a USB Storage Device

You can update the projector's firmware using a USB storage device.

1. Download the projector firmware file from the Epson support website. Make sure it is the correct firmware file for your model.
2. Copy the downloaded firmware file onto the root (top) folder of the USB storage device.

Note: Do not rename the firmware file. The USB device should be completely empty except for the firmware file and should be formatted in FAT format.

3. Turn on the projector.
4. Connect the USB storage device to the projector's **USB-A** port.
5. Press the **Menu** button, select **Initial/All Settings > Firmware Update** and press **Enter**.
6. Select **Yes** to start the firmware update.

Note: Do not disconnect the power cable or remove the USB storage device while the firmware is updating.

While the firmware is updating, all of the status indicators on the projector start flashing and the cooling fans run at high speed (this is normal). After the update is complete, the projector enters standby mode. If the **Direct Power On** setting is enabled, the projector restarts automatically.

After the update is complete, check the **Version** setting in the **Management > Information** menu to confirm that the firmware was updated successfully.

Parent topic: [Updating the Firmware](#)

Updating Projector Firmware Using a Computer and USB Cable

You can update the projector firmware using a computer and a USB cable.

Note: You need a USB Type A to USB Mini-B cable.

Your computer must be running one of the following operating systems when updating firmware:

- Windows 8.1 (32- and 64-bit)
 - Windows 10 (32- and 64-bit)
 - macOS 10.13.x (64-bit)
 - macOS 10.14.x (64-bit)
 - macOS 10.15.x (64-bit)
1. Download the projector firmware file from the Epson support website. Make sure it is the correct firmware file for your model.
 2. Turn on the projector.
 3. Connect the USB cable to the computer's USB port and to the projector's **Service** port.
 4. Press the **Menu** button, select **Initial/All Settings > Firmware Update** and press **Enter**.
 5. Select **Yes** to start the firmware update.

Note: Do not disconnect the power cable or remove the USB cable while the firmware is updating.

All of the status indicators on the projector start flashing, and the projector enters firmware update mode. The projector appears as a removable drive on the connected computer.

6. Copy the downloaded firmware file onto the root (top) directory of the projector's removable drive.

Note: Do not rename the firmware file.

7. Safely remove the projector's removable drive from the computer, then disconnect the USB cable from the projector.

The firmware update starts.

While the firmware is updating, the status indicators on the projector start flashing and the cooling fans run at high speed (this is normal). After the update is complete, the projector enters standby mode. If **Direct Power On** is enabled, the projector restarts automatically.

After the update is complete, check the **Version** setting in the **Management > Information** menu to confirm that the firmware was updated successfully.

Parent topic: [Updating the Firmware](#)

Transporting the Projector

The projector contains precision parts, some of which are glass. Follow these guidelines to transport, ship, or store the projector safely:

- Remove any equipment connected to the projector.
- Center the lens position using the **Lens** button.

Caution: If you transport the projector when the lens is not centered, the lens shift mechanism may be damaged.

- Make sure the lens shutter is closed.
- When transporting the projector a long distance or as checked luggage, pack it in a firm box with cushioning around it and mark the box "Fragile."
- When shipping the projector for repairs, place it in its original packing materials, if possible, or use equivalent materials with cushioning around the projector. Mark the box "Fragile."

Note: Epson shall not be liable for any damages incurred during transportation.

Parent topic: [Maintaining and Transporting the Projector](#)

Related tasks

[Turning Off the Projector](#)

Solving Problems

Check the solutions in these sections if you have any problems using the projector.

[Projection Problem Tips](#)

[Projector Light Status](#)

[Solving Image or Sound Problems](#)

[Solving Projector or Remote Control Operation Problems](#)

[Where to Get Help \(U.S. and Canada\)](#)

[Where to Get Help \(Latin America\)](#)

Projection Problem Tips

If the projector is not working properly, try turning it off and unplugging it. Then plug it back in and turn it on.

If this does not solve the problem, check the following:

- The lights on the projector may indicate what the problem is.
- The solutions in this manual can help you solve many problems.

If none of these solutions help, you can contact Epson for technical support.

Parent topic: [Solving Problems](#)

Related references

[Where to Get Help \(U.S. and Canada\)](#)

[Where to Get Help \(Latin America\)](#)

Projector Light Status

The lights on the projector indicate the projector status and let you know when a problem occurs. Check the status and color of the lights and look for a solution in the table here.

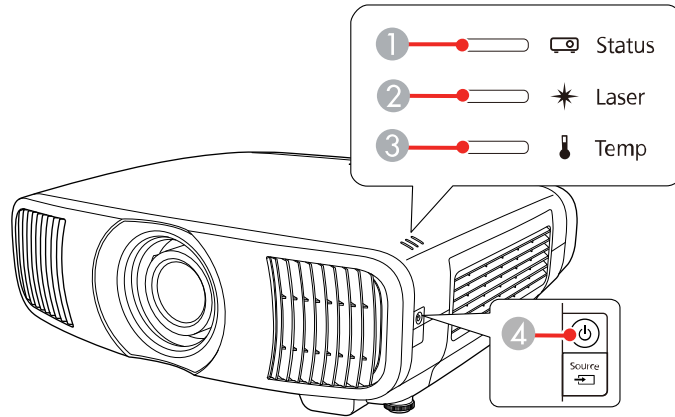

- 1 Status light
- 2 Laser light
- 3 Temp (temperature) light
- 4 Power light

Power light	Status light	Laser light	Temp light	Status and solution
Off	Off	Off	Off	Standby or sleep mode
Blue	Blue	Off	Off	Normal operation
Blue	Flashing blue	Off	Off	Warming up; wait for an image to appear (all buttons are disabled)
Flashing blue	Off	Off	Off	Preparing for monitoring (all features are disabled)
Blue	Off	Off	Off	Monitoring

Power light	Status light	Laser light	Temp light	Status and solution
Flashing blue	Varies	Varies	Flashing orange	<p>Projector is too hot</p> <ul style="list-style-type: none"> • Make sure that the vents and air filter are not clogged with dust or obstructed by nearby objects • Clean or replace the air filter • Make sure the environmental temperature is not too hot • If operating the projector at high altitude, turn on High Altitude Mode
Off	Flashing blue	Off	Orange	<p>Projector has overheated and turned off; leave it turned off to cool down for about five minutes. After the fan has stopped, do the following:</p> <ul style="list-style-type: none"> • Make sure that the vents and air filter are not clogged with dust or obstructed by nearby objects • Clean or replace the air filter • If operating the projector at high altitude, turn on High Altitude Mode • If the problem persists, unplug the projector and contact Epson for help
Off	Flashing blue	Off	Flashing orange	<p>A fan or sensor has a problem; turn the projector off, unplug it, and contact Epson for help</p>
Flashing blue	Varies	Flashing orange	Varies	<p>Laser warning; turn the projector off, unplug it, and contact Epson for help</p>
Off	Flashing blue	Orange	Off	<p>Laser problem; turn the projector off, unplug it, and contact Epson for help</p>

Power light	Status light	Laser light	Temp light	Status and solution
Off	Flashing blue	Flashing orange	Off	Internal projector error; turn the projector off, unplug it, and contact Epson for help
Off	Off	Flashing orange	Flashing orange	When copying menu settings, the batch setup file may be corrupt or the USB flash drive may not be correctly connected. Make sure the USB flash drive is not locked or encrypted. Disconnect the USB flash drive, unplug the power cord, and try again.
Flashing blue	Flashing blue	Flashing orange	Flashing orange	Copying settings may have failed and an error may have occurred in the projector's firmware. Turn the projector off, unplug it, and contact Epson for help.

Note: If the lights display a pattern not listed in the table above, turn the projector off, unplug it, and contact Epson for help.

Parent topic: [Solving Problems](#)

Related references

[Installation Settings - Installation Menu](#)

[Where to Get Help \(U.S. and Canada\)](#)

[Where to Get Help \(Latin America\)](#)

Related tasks

[Cleaning the Air Filter](#)

[Replacing the Air Filter](#)

Solving Image or Sound Problems

Check the solutions in these sections if you have any problems with projected images or sound.

[Solutions When No Image Appears](#)

[Solutions When "No Signal" Message Appears](#)

[Solutions When Only a Partial Image Appears](#)

[Solutions When the Image is Not Rectangular](#)

[Solutions When the Image Contains Noise or Static](#)

[Solutions When the Image is Fuzzy or Blurry](#)

[Solutions When the Image Brightness or Colors are Incorrect](#)

[Solutions to Image and Sound Syncing Problems](#)

[Solutions to Sound Problems](#)

Parent topic: [Solving Problems](#)

Solutions When No Image Appears

If no image appears, try the following solutions:

- Press the **Blank** button on the remote control to see if the image was temporarily turned off.
- Make sure all necessary cables are securely connected and the power is on for the projector and connected video sources.
- Try using a shorter HDMI cable.
- Try connecting the video source directly to the projector.
- Press the projector's power button to wake it from standby or sleep mode. Also see if your connected computer is in sleep mode or displaying a blank screen saver.
- If you are projecting from a streaming device, make sure it is powered by the USB power cable inside the projector. Turn on the connected streaming device or video source, and press the play button to start a video, if necessary.
- Make sure the connected device meets the HDMI CEC standard. See the documentation supplied with the device for more information. If necessary, set the CEC function for the connected device again and restart the device. Turn off the projector and the connected streaming device or video source, and then turn them back on.
- Turn off the projector and the connected streaming device or video source, and then turn them back on.
- Check the settings on the Signal I/O menu to make sure they are correct for the current video source.
- If you are projecting from a laptop computer, make sure it is set up to display on an external monitor.
- Make sure the computer's display resolution does not exceed the projector's resolution and frequency limits. If necessary, select a different display resolution for your computer. (See your computer manual for details.)
- Make sure you selected the correct **Signal Format** or **EDID** setting in the projector's Signal I/O menu, if available for your image source.

- If the other solutions do not solve the problem, reset all of the projector settings using the options on the **Initial/All Settings** menu.

Parent topic: [Solving Image or Sound Problems](#)

Related references

[Input Signal Settings - Signal I/O Menu](#)

Solutions When "No Signal" Message Appears

If the "No Signal" message appears, try the following solutions:

- Press a source button on the remote to select an available source. Wait a few seconds for an image to appear.
- Turn on the connected computer or video source, and press its play button to begin your presentation, if necessary.
- Check the connection from the projector to your video sources.
- If you are projecting from a laptop computer, make sure it is set up to display on an external monitor.
- If necessary, turn the projector and the connected computer or video source off and then on again.
- Try a different video cable.
- If you connected a streaming device, try a different power cable or use external power.
- If the other solutions do not solve the problem, reset all of the projector settings using the options on the **Initial/All Settings** menu.

[Displaying From a PC Laptop](#)

[Displaying From a Mac Laptop](#)

Parent topic: [Solving Image or Sound Problems](#)

Displaying From a PC Laptop

If you see the "No Signal" message when you display from a PC laptop, you need to set up the laptop to display on an external monitor.

1. Hold down the laptop's **Fn** key and press the key labeled with a monitor icon or **CRT/LCD**. (See your laptop manual for details.) Wait a few seconds for an image to appear. To display on both the laptop's monitor and the projector, try pressing the same keys again.

Note: On Windows 7 or later, hold down the Windows key and press **P** at the same time, then click **Duplicate**.

2. If the same image is not displayed by the laptop and projector, check the Windows **Display** utility to make sure the external monitor port is enabled and extended desktop mode is disabled. (See your computer or Windows manual for instructions.)
3. If necessary, check your video card settings and set the multiple display option to **Clone**, **Mirror**, or **Duplicate**.

Parent topic: [Solutions When "No Signal" Message Appears](#)

Displaying From a Mac Laptop

If you see the "No Signal" message when you display from a Mac laptop, you need to set up the laptop for mirrored display. (See your laptop manual for details.)

1. Open the **System Preferences** utility and select **Displays**, **Display**, or **Color LCD**.
2. Click the **Arrange** or **Arrangement** tab.
3. Select the **Mirror Displays** checkbox.

Parent topic: [Solutions When "No Signal" Message Appears](#)

Solutions When Only a Partial Image Appears

If only a partial computer image appears, try the following solutions:

- Try adjusting the image position using the **Lens** button on the remote control or control panel.
- Press the **Aspect** button on the remote control to select a different image aspect ratio.
- Check the **Blanking** setting in the Installation menu.
- Check your computer display settings to disable dual display and set the resolution within the projector's limits. (See your computer manual for details.)
- Check the resolution assigned to your presentation files to see if they are created for a different resolution than you are projecting in. (See your software help for details.)
- Make sure the lens shutter is fully open.
- Make sure you selected the correct **Projection** setting in the Installation menu.

Parent topic: [Solving Image or Sound Problems](#)

Related references

[Installation Settings - Installation Menu](#)

[Available Image Aspect Ratios](#)

Solutions When the Image is Not Rectangular

If the projected image is not evenly rectangular, try the following solutions:

- Place the projector directly in front of the center of the screen, facing it squarely, if possible.
- If you are mounting the projector from the ceiling, use the adjustment controls on the mount at the time of installation.
- Try to fix the image using lens shift before adjusting the **H/V-Keystone** setting.
- Adjust the image shape using the **Geometry Correction** menu settings.
- Adjust the **Quick Corner** setting to correct the image shape.
- Adjust the **Point Correction** setting to correct slight distortion that affects a portion of the screen.

Parent topic: [Solving Image or Sound Problems](#)

Related concepts

[Projector Placement](#)

Related tasks

[Correcting Image Shape with H/V-Keystone](#)

[Correcting Image Shape with Quick Corner](#)

[Correcting Image Shape with Point Correction](#)

Solutions When the Image Contains Noise or Static

If the projected image seems to contain electronic interference (noise) or static, try the following solutions:

- Check the cables connecting your computer or video source to the projector. They should be:
 - Separated from the power cord to prevent interference
 - Securely connected at both ends
 - Not connected to an extension cable
- Make sure you selected the correct **Signal Format** or **EDID** settings in the projector's Signal I/O menu, if available for your image source.
- Adjust the **Noise Reduction**, **MPEG Noise Reduction**, and **Deinterlacing** settings in the projector's Image menu.
- Adjust the **Blanking** setting in the Installation menu to hide noise or static on the edges of the projected image.

- Adjust the **HDMI IN EQ Level** setting in the projector's Signal I/O menu. Change the setting to **Low** if you are using a short HDMI cable, or change the setting to **High** if you are using a longer HDMI cable.
- Select a computer video resolution and refresh rate that are compatible with the projector.
- If you adjusted the image shape using the projector controls, try decreasing the **Sharpness** setting to improve image quality.
- If you connected an extension power cable, try projecting without it to see if it caused interference in the signal.
- If you connected an A/V system that does not support eARC/ARC to the **HDMI2 (eARC/ARC)** port, the image may be distorted.

Parent topic: [Solving Image or Sound Problems](#)

Related references

[Input Signal Settings - Signal I/O Menu](#)

[Image Quality Settings - Image Menu](#)

[Installation Settings - Installation Menu](#)

Related tasks

[Adjusting Image Sharpness](#)

Solutions When the Image is Fuzzy or Blurry

If the projected image is fuzzy or blurry, try the following solutions:

- Adjust the image focus.
- Clean the projector lens.
- Check the lens for condensation.

Note: To avoid condensation on the lens after bringing the projector in from a cold environment, let the projector warm up to room temperature before using it.

- Position the projector close enough to the screen, and directly in front of it.
- Adjust the **Sharpness** setting to improve image quality.
- If you are projecting from a computer, adjust the computer's resolution to match the projector's native resolution, if possible.

Parent topic: [Solving Image or Sound Problems](#)

Related concepts

[Projector Placement](#)

Related references

[Image Quality Settings - Image Menu](#)

Related tasks

[Focusing the Image with the Lens Button](#)

[Cleaning the Lens](#)

[Adjusting Image Sharpness](#)

Solutions When the Image Brightness or Colors are Incorrect

If the projected image is too dark or light, or the colors are incorrect, try the following solutions:

- Press the **Color Mode** button on the remote control to try different color modes for the image and environment.
- Check your video source settings.
- Adjust the available settings on the Image menu for the current input source, such as **Brightness**, **Contrast**, **Tint**, **Color Saturation**, and **RGBCMY**. RGBCMY should be set by a professional color calibrator using specialized color calibration tools in a controlled lighting environment.
- Make sure you selected the correct **Signal Format** or **EDID** setting in the Signal I/O menu, if available for your video source.
- For HDR images, set the **Dynamic Range** setting to **Auto**.
- Make sure all the cables are securely connected to the projector and your video device. If you connected long cables, try connecting shorter cables.
- Position the projector close enough to the screen.

Parent topic: [Solving Image or Sound Problems](#)

Related concepts

[Projector Placement](#)

Related references

[Image Quality Settings - Image Menu](#)

[Input Signal Settings - Signal I/O Menu](#)

[Available Color Modes](#)

Related tasks

[Adjusting the Projector's Brightness Level](#)

[Adjusting the Hue, Saturation, and Brightness](#)

[Adjusting the Color Temperature](#)

Solutions to Image and Sound Syncing Problems

If the projected image and the output sound are not in sync, try the following solutions:

- Change the **Image Processing** setting to **Fast** in the projector's Signal I/O menu.
- If the **Image Processing** setting is set to **Fine** in the projector's Signal I/O menu, turn the **Frame Interpolation** setting off in the Image menu.
- Adjust the sound output settings of the video devices connected to the projector. For details, see the documentation supplied with your video device.

Parent topic: [Solving Image or Sound Problems](#)

Related references

[Image Quality Settings - Image Menu](#)

[Input Signal Settings - Signal I/O Menu](#)

Solutions to Sound Problems

If there is no sound when you expect it or the volume is too low or high, try the following solutions:

- Check your computer or video source to make sure the volume is turned up and the audio output is set for the correct source.
- Check the cable connection between the projector and your video source.
- If you are using an eARC/ARC-compatible A/V system, try the following solutions:
 - Make sure your A/V system is connected to the projector's eARC/ARC compatible HDMI port.
 - Make sure the cable meets the HDMI CEC standard.
 - Make sure the connected A/V system meets the HDMI CEC standard. See the documentation supplied with the device for more information.

Parent topic: [Solving Image or Sound Problems](#)

Solving Projector or Remote Control Operation Problems

Check the solutions in these sections if you have problems operating the projector or remote control.

[Solutions to Projector Power or Shut-Off Problems](#)

[Solutions to Remote Control Problems](#)

[Solutions to HDMI Link Problems](#)

Parent topic: [Solving Problems](#)

Solutions to Projector Power or Shut-Off Problems

If the projector does not come on when you press the power button or it shuts off unexpectedly, try the following solutions:

- Make sure the power cord is securely connected to the projector and to a working electrical outlet.
- The projector's buttons may be locked for security. Unlock the buttons or use the remote control to turn on the projector.
- If the projector's light source shuts off unexpectedly, it may have entered standby mode after a period of inactivity. Press the power button to wake the projector and adjust the **Sleep Mode Timer** setting to change the sleep interval.
- Turn off the **HDMI Link** setting. If this resolves the issue, check the settings on connected devices and make sure the projector is not receiving shut down requests over CEC.
- If the projector's light source shuts off, the Status light is flashing blue, and the Temp light is orange, the projector has overheated and shut off. Check the solutions for this light status.
- If the power button on the remote control does not turn on the projector, check its batteries.
- The power cord may be defective. Try another power cord. If that doesn't work, disconnect the cord and contact Epson.

Parent topic: [Solving Projector or Remote Control Operation Problems](#)

Related references

[Feature Settings - Operation Menu](#)

[Input Signal Settings - Signal I/O Menu](#)

[Projector Light Status](#)

[Where to Get Help \(U.S. and Canada\)](#)

[Where to Get Help \(Latin America\)](#)

Related tasks

[Unlocking the Projector's Buttons](#)

[Replacing the Remote Control Batteries](#)

Solutions to Remote Control Problems

If the projector does not respond to remote control commands, try the following solutions:

- Check that the remote control batteries are installed correctly and have power. If necessary, replace the batteries.

- Make sure you are operating the remote control within the reception angle and range of the projector.
- Make sure the projector is not warming up or shutting down.
- Check to see if a button on the remote control is stuck down, causing it to enter sleep mode. Release the button to wake the remote control up.
- Strong fluorescent lighting, direct sunlight, or infrared device signals may be interfering with the projector's remote receivers. Dim the lights or move the projector away from the sun or interfering equipment.
- If you lose the remote control, you can purchase another from an Epson parts distributor.

Parent topic: [Solving Projector or Remote Control Operation Problems](#)

Related references

[Where to Get Help \(U.S. and Canada\)](#)

[Where to Get Help \(Latin America\)](#)

[Remote Control Operation](#)

Related tasks

[Replacing the Remote Control Batteries](#)

Solutions to HDMI Link Problems

If you cannot control an HDMI device using the HDMI Link feature, try the following solutions:

- Make sure all necessary cables are securely connected and the power is on for the projector and connected video sources.
- Make sure the cables meet the HDMI CEC standard.
- Make sure the connected device meets the HDMI CEC standard. See the documentation supplied with the device for more information.
- Make sure the **HDMI Link** setting is set to **On**.
- Check if the device is available in the **Device Connections** list in the Signal I/O menu. If the device does not appear, it does not meet the HDMI CEC standards. Connect a different device.
- Make sure the connected devices are turned on and in standby status. See the documentation supplied with the device for more information.
- If you connected a new device or changed any connections, make sure the CEC function is set for the connected device. You may need to restart the device.
- Connect no more than three devices that support HDMI CEC at the same time.

Parent topic: [Solving Projector or Remote Control Operation Problems](#)

Related references

[Input Signal Settings - Signal I/O Menu](#)

Where to Get Help (U.S. and Canada)

If you need to contact Epson for technical support services, use the following support options.

Internet Support

Visit Epson's support website at epson.com/support (U.S.) or epson.ca/support (Canada) and select your product for solutions to common problems with your projector. You can download utilities and documentation, get FAQs and troubleshooting advice, or e-mail Epson with your questions.

Speak to a Support Representative

To use the Epson PrivateLine Support service, call (800) 637-7661. This service is available for the duration of your warranty period. You may also speak with a projector support specialist by dialing (562) 276-4394 (U.S.) or (905) 709-3839 (Canada).

Support hours are Monday through Friday, 7 AM to 4 PM, Pacific Time.

Days and hours of support are subject to change without notice. Toll or long distance charges may apply.

Before you call, have the following information ready:

- Product name
- Product serial number (located on the bottom or rear of the projector, or in the menu system)
- Proof of purchase (such as a store receipt) and date of purchase
- Computer or video configuration
- Description of the problem

Purchase Supplies and Accessories

You can purchase screens, other optional accessories, and replacement parts from an Epson authorized reseller. To find the nearest reseller, call 800-GO-EPSON (800-463-7766) in the U.S. or 800-807-7766 in Canada. Or you can purchase online at epsonstore.com (U.S. sales) or epsonstore.ca (Canadian sales).

You can purchase a replacement remote control from an Epson parts distributor [here](#) (U.S. sales) or [here](#) (Canadian sales).

Parent topic: [Solving Problems](#)

Where to Get Help (Latin America)

If you need to contact Epson for technical support services, use the following support options.

Internet Support

Visit Epson's support website at latin.epson.com/support and select your product for solutions to common problems with your projector. You can download utilities and documentation, get FAQs and troubleshooting advice, or e-mail Epson with your questions.

Speak to a Support Representative

Before you call for support, please have the following information ready:

- Product name
- Product serial number (located on the bottom or rear of the projector, or in menu system)
- Proof of purchase (such as a store receipt) and date of purchase
- Computer or video configuration
- Description of the problem

Then call:

Country	Telephone
Argentina	(54 11) 5167-0300 0800-288-37766
Bolivia*	800-100-116
Brazil	0800-007-5000
Chile	(56 2) 2484-3400
Colombia	Bogota: (57 1) 592-2200 Other cities: 018000-915235
Costa Rica	800-377-6627
Dominican Republic*	1-888-760-0068
Ecuador*	1-800-000-044
El Salvador*	800-6570
Guatemala*	1-800-835-0358

Country	Telephone
Mexico	Mexico City: (52 55) 1323-2052 Other cities: 01-800-087-1080
Nicaragua*	00-1-800-226-0368
Panama*	00-800-052-1376
Paraguay	009-800-521-0019
Peru	Lima: (51 1) 418-0210 Other cities: 0800-10126
Uruguay	00040-5210067
Venezuela	(58 212) 240-1111

*Contact your local phone company to call this toll-free number from a mobile phone.

Note: Toll or long distance charges may apply. If your country does not appear on the list, contact the sales office in the nearest country.

Purchase Supplies and Accessories

You can purchase optional accessories and replacement parts from an Epson authorized reseller. To find the nearest reseller, go to latin.epson.com. Or you can contact your nearest sales office as described in "Where to Get Help."

Parent topic: [Solving Problems](#)

Technical Specifications

These sections list the technical specifications of your projector.

[General Projector Specifications](#)

[Projector Light Source Specifications](#)

[Remote Control Specifications](#)

[Projector Dimension Specifications](#)

[Projector Electrical Specifications](#)

[Projector Environmental Specifications](#)

[Projector Safety and Approvals Specifications](#)

[Supported Video Display Formats](#)

General Projector Specifications

Type of display	Poly-silicon TFT active matrix
Resolution	1920 × 1080 (×3) pixels (Full HD)
Lens	F=2.0 to 3.0 Focal length: 22.5 to 46.7 mm
Color reproduction	Full color, up to 1 billion colors
Brightness	Normal Light Output: White light output 2700 lumens (ISO 21118 standard) Color light output 2700 lumens ECO Light Output: White light output 1000 lumens (ISO 21118 standard) Color light output 1000 lumens

Note: Color brightness (color light output) and white brightness (white light output) will vary depending on usage conditions. Color light output measured in accordance with IDMS 15.4; white light output measured in accordance with ISO 21118.

Contrast ratio	2500000:1 with Dynamic Contrast on, Normal Light Output, Dynamic Color Mode, Wide Zoom mode, and Lens Shift Vertical: -50% or 50% and Horizontal: Centered
Image size (in native aspect ratio)	50 inches (1.27 m) to 300 inches (7.62 m)
Projection distance (in native aspect ratio)	58 inches (1.47 m) to 748 inches (19 m)
Projection methods	Front, rear, ceiling-mounted
Optical aspect ratio (width-to-height)	16:9
Focus adjustment	Powered
Zoom adjustment	Optical, powered
Zoom ratio (Tele-to-Wide)	1 to 2.1
Noise level	30 dB (Normal Light Output) 22 dB (ECO Light Output)
Keystone correction angle	± 30° vertical/horizontal
Service port compatibility	USB 1.1 and 2.0 compliant for service and firmware update (USB Mini-B cable)
USB-A port compatibility	USB 1.1 and 2.0 compliant for connecting a streaming device, saving error log files, batch settings, and firmware update with 5V/2A power supply
Opt.HDMI port compatibility	USB 1.1 and 2.0 compliant for an optical HDMI cable with 5V/300mA power supply only (no USB function)
Trigger Out port	12V (200mA maximum) Mono cable: tip and sleeve (monaural 2-pin), signal tip trigger + 12V DC, sleeve GND Stereo (TRS) cable: signal tip trigger + 12V DC, ring not connected, sleeve GND

Parent topic: [Technical Specifications](#)

Projector Light Source Specifications

Type	Laser diode
Light source output power	Up to 80 W
Wavelength	449 to 461 nm
Light source life	Up to about 20,000 hours

Note: Turn off this product when not in use to prolong the life of the projector. Laser life will vary depending upon mode selected, environmental conditions, and usage. Brightness decreases over time.

Parent topic: [Technical Specifications](#)

Remote Control Specifications

Reception range	32 feet (10 m)
Batteries	Two (2) alkaline or manganese AA

Parent topic: [Technical Specifications](#)

Projector Dimension Specifications

Height (excluding feet)	6.7 inches (169 mm)
Width	20.5 inches (520 mm)
Depth	17.6 inches (447 mm)
Weight	Approximately 28 lb (12.7 kg)

For mounting

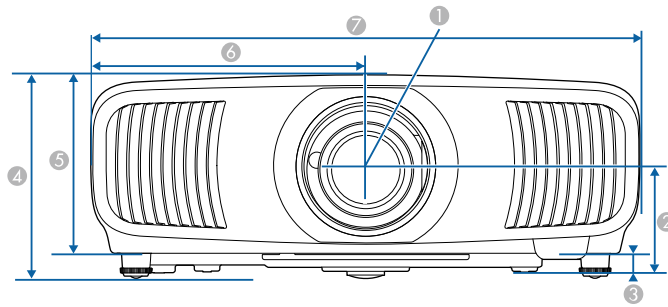

- 1 Center of lens
- 2 Distance from center of lens to suspension bracket fixing point: 3.8 inches (96.1 mm)
- 3 0.7 inches (17.1 mm)
- 4 7.6 inches (192.7 mm)
- 5 6.7 inches (169 mm)
- 6 10.2 inches (260 mm)

7 20.5 inches (520 mm)

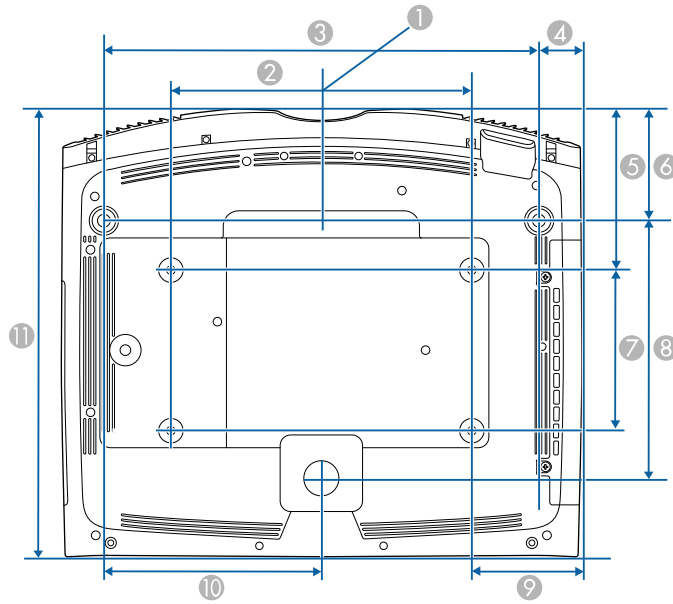

- 1 Center of lens
- 2 11.8 inches (300 mm)
- 3 17.1 inches (434 mm)
- 4 1.7 inches (43 mm)
- 5 6.3 inches (160.6 mm)
- 6 4.4 inches (111 mm)
- 7 6.3 inches (160 mm)
- 8 10.1 inches (257.2 mm)
- 9 4.3 inches (110 mm)
- 10 8.5 inches (217 mm)
- 11 17.6 inches (447 mm)

Parent topic: [Technical Specifications](#)

Projector Electrical Specifications

Rated frequency	50/60 Hz
Power supply	100 to 240 VAC \pm 10% 3.2 to 1.5 A
Power consumption (100 to 120 V)	Operating: Normal Light Output: 311 W ECO Light Output: 204 W Standby: 0.4 W (Communication Off), 2 W (Communication On)
Power consumption (220 to 240 V)	Operating: Normal Light Output: 302 W ECO Light Output: 198 W Standby: 0.4 W (Communication Off), 2 W (Communication On)

Parent topic: [Technical Specifications](#)

Projector Environmental Specifications

Temperature	Operating: 41 to 95 °F (5 to 35 °C) up to 7500 ft (2286 m) Operating: 41 to 86 °F (5 to 30 °C) above 7500 ft (2286 m) Storage: 14 to 140 °F (–10 to 60 °C)
Humidity (relative, non-condensing)	Operating: 20 to 80% Storage: 10 to 90%
Operating altitude	Up to 4921 feet (1500 m) Up to 10000 feet (3048 m) with High Altitude Mode enabled

Parent topic: [Technical Specifications](#)

Projector Safety and Approvals Specifications

United States

FCC Part 15 Class B (DoC)

UL60950-1 2nd edition (cTUVus Mark) / UL62368-1 2nd edition (cTUVus Mark)

Canada

ICES-003 Class B

CSA C22.2 No. 60950-1-07 (cTUVus Mark) / CSA C22.2 No. 62368-1-14 (cTUVus Mark)

Parent topic: [Technical Specifications](#)

Supported Video Display Formats

For best results, your computer's monitor port or video card resolution should be set to display in the projector's native resolution. However, your projector includes Epson's SizeWise chip that supports other computer display resolutions, so your image will be resized to fit automatically.

Your computer's monitor port or video card refresh rate (vertical frequency) must be compatible with the projector. (See your computer or video card manual for details.)

The table here lists the compatible refresh rate and resolution for each compatible video display format.

HDMI input signals

Display format	Refresh rate (in Hz)	Resolution (in pixels)
VGA	60	640 × 480
SDTV (480i/480p)	60	720 × 480
SDTV (576i/576p)	50	720 × 576
HDTV (720p)	50/60	1280 × 720
HDTV (1080i)	50/60	1920 × 1080
HDTV (1080p)	24/30/50/60	1920 × 1080
	60	2560 × 1080
4K × 2K	24/25/30/50/60/100/120	3840 × 2160
	24/50/60/100/120	4096 × 2160

Parent topic: [Technical Specifications](#)

Notices

Check these sections for important notices about your projector.

[Recycling \(U.S. and Canada\)](#)

[Important Safety Information](#)

[Laser Safety Information](#)

[Important Safety Instructions](#)

[List of Safety Symbols \(corresponding to IEC60950-1 A2\)](#)

[FCC Compliance Statement](#)

[Binding Arbitration and Class Waiver](#)

[Trademarks](#)

[Copyright Notice](#)

Recycling (U.S. and Canada)

Epson offers a recycling program for end of life products. Please go to [this site](#) for information on how to return your products for proper disposal.

Parent topic: [Notices](#)

Important Safety Information

Caution: Never look into the projector lens when the laser is turned on; the bright light can damage your eyes. Never let children look into the lens when it is on. Never open any cover on the projector, except the filter covers. Dangerous electrical voltages inside the projector can severely injure you. Except as specifically explained in this *User's Guide*, do not attempt to service this product yourself. Refer all servicing to qualified service personnel.

Warning: The projector and its accessories come packaged in plastic bags. Keep plastic bags away from small children to avoid any risk of suffocation.

Parent topic: [Notices](#)

Laser Safety Information

This projector is a Class 1 laser product that complies with the IEC/EN60825-1:2014 international standard for lasers. Follow these safety instructions when using the projector.

Warning: Possibly hazardous optical radiation emitted from this product. Do not look at operating light source. Eye injury may result.



Warning: MOUNT ABOVE THE HEADS OF CHILDREN. The use of a ceiling mount is recommended with this product to place it above the eyes of children.

- If an error occurs in the projector, turn off the power and unplug the projector immediately. Continuing to use the projector could result in an electric shock, fire, or visual impairment. Contact Epson support.
- Do not attempt to disassemble or modify the projector. The projector contains a high-power laser component. Serious injury could result.
- Do not look into the lens during projection. Also, do not look into the lens using optical devices, such as a magnifying glass or telescope. This could cause visual impairment.
- Do not place flammable objects in front of the lens. Objects could catch fire.
- When turning on the projector at a distance using the remote control, make sure no one is looking into the lens.
- Do not allow small children to operate the projector. Children must be accompanied by an adult.
- Do not apply optical devices, such as a magnifying glass or reflector, to the projected image. Using the projector may result in physical harm, fire, or an accident.
- Do not block the light from the lens during projection. The high temperature in this area could cause burns, fire, or other damage. The lens may overheat due to the reflected light and could cause the projector to malfunction.
- Before using the projector, make sure there is nothing in the area that could reflect the projected image.
- When disposing of the projector, do not disassemble it. Dispose of the projector in accordance with your local or national laws and regulations.

Labels are attached to the projector to indicate it is a Class 1 laser product and complies with FDA performance standards for laser products except for conformance as a Risk Group 2 LIP as defined in IEC 62471-5: Ed. 1.0 (for more information see Laser Notice No. 57, dated May 8, 2019):

- **Top**

As with any bright source, do not stare into the beam (RG2 IEC/EN 62471-5:2015).

⚠ WARNING	
 RG2	WARNING: Never look into the lens.
	AVERTISSEMENT : Ne regardez jamais dans l'objectif.
	WARNUNG: Blicken Sie niemals in das Objektiv.
	ADVERTENCIA: No mire nunca a través del objetivo.
	警告: 作動中は、絶対にレンズをのぞかないでください。 경고: 작동중 절대 렌즈 안을 보지 마십시오. 警告: 不要直视镜头。 警告: 請勿直視鏡頭。
⚠ CAUTION	
 	CAUTION: Do not put your finger in the moving parts of the projector's lens.
	ATTENTION : Ne pas mettre le doigt dans les parties mobiles de l'objectif du projecteur.
	ACHTUNG: Vermeiden Sie den Kontakt mit beweglichen Teilen der Linse.
	PRECAUCIÓN: No ponga los dedos sobre las partes móviles de las lentes del proyector.
	注意: レンズ可動部に指を挿まないようにしてください。 주의: 프로젝터 렌즈의 움직이는 부분에 손가락을 넣지 마세요. 注意: 不要将手指伸入机身与镜头的缝隙, 以免被夹伤。 注意: 請勿將手指伸入機身與鏡頭的隙縫中, 以免被夾傷。

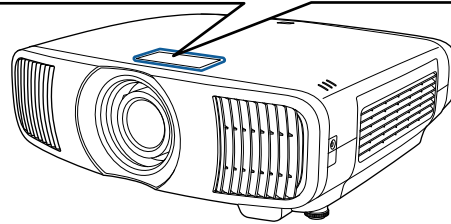

• Inside

⚠ DANGER	
DANGER: CLASS 4 LASER RADIATION WHEN OPEN. AVOID EYE OR SKIN EXPOSURE TO DIRECT OR SCATTERED RADIATION.	
DANGER : EN CAS D'OUVERTURE RAYONNEMENT LASER DE CLASSE 4. ÉVITER L'EXPOSITION DES YEUX OU DE LA PEAU AUX RAYONNEMENTS DIRECTS OU DIFFUSÉS.	
PELIGRO: RADIACIÓN LÁSER DE CLASE 4 CUANDO ESTÁ ABIERTO. EVITAR LA EXPOSICIÓN DE OJOS O PIEL A LA RADIACIÓN DIRECTA O DISPERSA.	
GEFAHR: LASERSTRAHLUNG KLASSE 4 WENN GEÖFFNET. BESTRAHLUNG VON AUGE ODER HAUT DURCH DIREKTE ODER STREUSTRALUNG VERMEIDEN.	
危険: 打开时有 4 类激光辐射。避免眼或皮肤受到直射或散射辐射的照射。	
危険: 打開時具有第 4 級 (CLASS 4) 雷射。避免眼睛或皮膚暴露於直射或散射的輻射。	
위험: 개방시 4 등급 레이저 제품. 직접 혹은 분사 방식에 대한 눈 또는 피부 노출을 피하십시오.	
危険: ここを開くとクラス 4 のレーザー放射が出る。ビームや散乱光の目又は皮膚への被ばくを避けること。	

Important Safety Instructions

Follow these safety instructions when setting up and using the projector:

- Do not look into the lens when the projector is on. The bright light can damage your eyes. Avoid standing in front of the projector so the bright light does not shine into your eyes.
- Do not place any flammable objects in front of the projector lens, otherwise, a fire may occur.
- Do not touch the lens with bare hands.
- Do not place the projector on an unstable cart, stand, or table or on a surface that is unable to support its weight. Otherwise, it could fall or topple causing an accident and injury.
- If the projector is mounted on a ceiling or wall, it should be installed by qualified technicians using mounting hardware designed for use with this projector. When installing the projector in a high position, take measures to prevent it from falling by using wires to ensure safety in an emergency, such as an earthquake, and to prevent accidents. If the projector is not installed correctly, the projector could fall. This may result in injury or accidents. Contact your dealer to carry out the installation work.
- Failure to install the ceiling mount and projector may cause the projector to fall. After installing the specific Epson mount that supports your projector, make sure you secure the mount to all of the projector's ceiling mount fixing points. Also, secure the projector and the mounts using wire that is strong enough to hold their weight.
- Do not install in locations where salt damage could occur, or in locations subject to corrosive gas such as sulphuric gas from hot springs. Otherwise, corrosion could cause the projector to fall. It could also cause the projector to malfunction.
- When installing or adjusting a ceiling or wall mount, do not use adhesives to prevent the screws from loosening and do not use oils or lubricants. This may cause the projector case to crack and the projector to fall from its ceiling mount. This could cause serious injury to anyone under the mount and could damage the projector.
- Do not install the projector in locations exposed to high humidity and dust, such as on a kitchen counter, in the kitchen, or near a humidifier, or in locations exposed to oil smoke or steam. Doing so could cause fire or electric shock.

Examples of environments that could cause the projector to fall due to case deterioration:

- Locations subject to excessive smoke or airborne oil particles, such as factories or kitchens
- Locations containing volatile solvents or chemicals, such as factories or laboratories
- Locations where the projector could be subjected to detergents or chemicals, such as factories or kitchens

- Locations in which aroma oils are often used, such as relaxation rooms
- Near devices that produce excessive smoke, airborne oil particles, or foam at events
- Do not use the projector near water, sources of heat, high-voltage electrical wires, or sources of magnetic fields.
- Use the type of power source indicated on the projector. Use of a different power source may result in fire or electric shock. If you are not sure of the power available, consult your dealer or power company.
- Place the projector near a wall outlet where the plug can be easily unplugged.
- Take the following precautions when handling the plug: Do not hold the plug with wet hands. Do not insert the plug into a dusty outlet. Insert the plug firmly into the outlet. Do not pull the power cord when disconnecting the plug; always be sure to hold the plug when disconnecting it. Do not overload wall outlets, extension cords, or power strips. Failure to comply with these precautions could result in fire or electric shock.
- Do not place the projector where the cord can be walked on. This may result in fraying or damage to the plug.
- Unplug the projector from the wall outlet and allow to cool before cleaning. Use a dry cloth (or, for stubborn dirt or stains, a moist cloth that has been wrung dry) for cleaning. Do not use liquid or aerosol cleaners, any sprays containing flammable gas, or solvents such as alcohol, paint thinner, or benzene.
- Do not block the slots and openings in the projector case. They provide ventilation and prevent the projector from overheating. If the vents are covered, the internal temperature could rise and cause a fire. Do not place the projector in locations subject to high temperatures, such as near heating equipment. Do not operate the projector on a sofa, rug, or other soft surface, or set it on top of loose papers. Do not cover the projector with a blanket, curtain, or tablecloth. If you are setting up the projector near a wall, leave at least 7.9 inches (20 cm) of space between the wall and the projector.
- Do not operate the projector in a closed-in cabinet unless proper ventilation is provided.
- Never allow objects of any kind to enter any openings in the projector. Do not leave objects, especially flammable objects, near the projector. Never spill liquid of any kind into the projector.
- You may need to clean the air filter and vent. A clogged air filter or vent can block ventilation needed to cool the projector. Do not use canned air, or the gases may leave a residue.
- Do not use or store the projector in locations where it will be subject to dust or dirt. Otherwise, the quality of the projected image may decline, or the air filter may become clogged, resulting in a malfunction or fire.
- Do not store the projector outdoors for an extended length of time.

- Except as specifically explained in this manual, do not attempt to service this product yourself. Refer all servicing to qualified personnel. Opening or removing covers may expose you to dangerous voltages and other hazards.
- Never open any covers on the projector except as specifically explained in this manual. Never attempt to disassemble or modify the projector. Refer all repairs to qualified service personnel. Electrical voltages inside the projector can cause serious injury.
- Unplug the projector from the wall outlet and refer servicing to qualified service personnel under the following conditions: if it does not operate normally when you follow the operating instructions, or exhibits a distinct change in performance; if smoke, strange odors, or strange noises come from the projector; if the power cord or plug is damaged or frayed; if liquid or foreign objects get inside the projector, or if it has been exposed to rain or water; if it has been dropped or the housing has been damaged. Continuing to use the projector under these conditions may result in fire or electric shock.
- Do not touch the plug during an electrical storm. Otherwise, you may receive an electric shock.
- Unplug the projector when it will not be used for extended periods.
- Do not use the projector where it may be exposed to rain, water, or excessive humidity.
- Do not use or store the projector where it may be exposed to smoke, steam, corrosive gases, excessive dust, vibration, or shock. Doing so may result in malfunction, electric shock, and fire.
- Do not use or store the projector in places where smoke from oil or cigarettes may be present, as it can adversely affect the quality of the projected images.
- Do not use the projector where flammable or explosive gases may be present.
- Do not use or store the projector or remote control in a hot location, such as near a heater, in direct sunlight, or in a closed vehicle.
- Check the specifications for the power cable. Using an inappropriate power cable could result in fire or electric shock. The power cable supplied with the projector is intended to comply with power supply requirements for the country of purchase. If you use the projector in the country where it was purchased, only use the power cable that came with the projector.
- If you use the projector in a country other than where you purchased it, use the correct power cord for that country.
- Do not stand on the projector or place heavy objects on it.
- Do not use the projector outside of the required temperature range below:
41 to 95 °F (5 to 35 °C) at an altitude of 7500 feet (2286 m) or less, or 41 to 86 °F (5 to 30 °C) at an altitude of 7500 to 10000 feet (2286 m to 3048 m)
Doing so may cause an unstable display and could lead to projector damage. Do not use or store the projector where it may be exposed to sudden changes in temperature.

- Do not store the projector outside of the required temperature range of 14 to 140 °F (–10 to 60 °C) or in direct sunlight for long periods of time. Doing so may cause damage to the case.
- Do not place anything that can become warped or damaged by heat near the exhaust vents. Do not bring your hands or face close to the vents while projection is in progress. Do not bring your face close to the projector while it is in use.
- Before you move the projector, make sure its power is turned off, the plug is disconnected from the outlet, and all cables are disconnected.
- Do not place the source of an open flame, such as a lit candle, on or near the projector.
- During projection, do not block the light from the projector with a book or other objects. If the light from the projector is blocked, the area on which the light shines becomes hot which could cause it to melt, burn, or start a fire. Also, the lens may get hot due to the reflected light which could cause the projector to malfunction. To stop projection, use the A/V Mute function, or turn off the projector.
- Do not modify the power cord. Do not place heavy objects on top of the power cord or bend, twist, or pull it excessively. Keep the power cord away from hot electrical appliances.
- Always lower the volume before turning off the projector. Turning on the projector with the volume too high can damage your ears.
- When a still image is displayed for a long time, image retention may occur on the screen. Do not display images in the exact same position for long periods.

[Restriction of Use](#)

Parent topic: [Notices](#)

Restriction of Use







When this product is used for applications requiring high reliability/safety such as transportation devices related to aviation, rail, marine, automotive; disaster prevention devices; various safety devices; or functional/precision devices, you should use this product only after giving consideration to including fail-safes and redundancies into your design to maintain safety and total system reliability.







Because this product was not intended for use in applications requiring extremely high reliability/safety such as aerospace equipment, main communication equipment, nuclear power control equipment, or medical equipment related to direct medical care, please make your own judgment on this product's suitability after a full evaluation.









Parent topic: [Important Safety Instructions](#)









List of Safety Symbols (corresponding to IEC60950-1 A2)

The following table lists the meaning of the safety symbols labeled on the equipment.

No.	Symbol	Approved Standards	Description
1		IEC60417 No. 5007	"ON" (power) To indicate connection to the mains.
2		IEC60417 No. 5008	"OFF" (power) To indicate disconnection from the mains.
3		IEC60417 No. 5009	Stand-by To identify the switch or switch position by means of which part of the equipment is switched on in order to bring it into the stand-by condition.
4		ISO7000 No. 0434B, IEC3864-B3.1	Caution To identify general caution when using the product.
5		IEC60417 No. 5041	Caution, hot surface To indicate that the marked item can be hot and should not be touched without taking care.
6		IEC60417 No. 6042 ISO3864-B3.6	Caution, risk of electric shock To identify equipment that has risk of electric shock.
7		IEC60417 No. 5957	For indoor use only To identify electrical equipment designed primarily for indoor use.

No.	Symbol	Approved Standards	Description
8		IEC60417 No. 5926	Polarity of DC power connector To identify the positive and negative connections (the polarity) on a piece of equipment to which a DC power supply may be connected.
9		—	Polarity of DC power connector To identify the positive and negative connections (the polarity) on a piece of equipment to which a DC. power supply may be connected.
10		IEC60417 No. 5001B	Battery, general On battery powered equipment. To identify a device for instance a cover for the battery compartment, or the connector terminals.
11		IEC60417 No. 5002	Positioning of cell To identify the battery holder itself and to identify the positioning of the cell(s) inside the battery holder.
12		—	Positioning of cell To identify the battery holder itself and to identify the positioning of the cell(s) inside the battery holder.
13		IEC60417 No. 5019	Protective earth To identify any terminal which is intended for connection to an external conductor for protection against electric shock in case of a fault, or the terminal of a protective earth electrode.
14		IEC60417 No. 5017	Earth To identify an earth (ground) terminal in cases where neither the symbol No.13 is explicitly required.

No.	Symbol	Approved Standards	Description
15		IEC60417 No. 5032	Alternating current To indicate on the rating plate that the equipment is suitable for alternating current only; to identify relevant terminals.
16		IEC60417 No. 5031	Direct current To indicate on the rating plate that the equipment is suitable for direct current only; to identify relevant terminals.
17		IEC60417 No. 5172	Class II equipment To identify equipment meeting the safety requirements specified for Class II equipment according to IEC 61140.
18		ISO 3864	General prohibition To identify actions or operations that are prohibited.
19		ISO 3864	Contact prohibition To indicate injury that could occur due to touching a specific part of the equipment.
20		—	Never look into the optical lens while the projector is on.
21		—	To indicate don't place anything on projector.
22		ISO3864 IEC60825-1	Caution, laser radiation To indicate the equipment has a laser radiation part.

No.	Symbol	Approved Standards	Description
23		ISO 3864	Disassembly prohibition To indicate a risk of injury, such as electric shock, if the equipment is disassembled.
24		IEC60417 No. 5266	Standby, partial standby To indicate that part of the equipment is in the ready status.
25		ISO3864 IEC60417 No. 5057	Caution, movable parts To indicate that you must keep away from movable parts according to protection standards.
26		IEC 60417 No. 6056	Caution (moving fan blades) To indicate that you must keep away from the moving fan blades.
27		IEC 60417 No. 6043	Caution (sharp corners) To indicate sharp corners that should not be touched.
28		—	To indicate that looking into the lens while projecting is prohibited.
29		ISO7010 No. W027 ISO 3864	Warning, optical radiation (such as UV, visible radiation, IR) Take care to avoid injury to eyes and skin when in the vicinity of optical radiation.
30		IEC60417 No. 5109	Not to be used in residential areas To identify electrical equipment which is not suitable for a residential area.

Parent topic: [Notices](#)

FCC Compliance Statement

For United States Users

This equipment has been tested and found to comply with the limits for a Class B digital device, pursuant to Part 15 of the FCC Rules. These limits are designed to provide reasonable protection against harmful interference in a residential installation. This equipment generates, uses, and can radiate radio frequency energy and, if not installed and used in accordance with the instructions, may cause harmful interference to radio communications. However, there is no guarantee that interference will not occur in a particular installation. If this equipment does cause interference to radio and television reception, which can be determined by turning the equipment off and on, the user is encouraged to try to correct the interference by one or more of the following measures:

- Reorient or relocate the receiving antenna.
- Increase the separation between the equipment and receiver.
- Connect the equipment into an outlet on a circuit different from that to which the receiver is connected.
- Consult the dealer or an experienced radio/TV technician for help.

This device complies with part 15 of the FCC Rules. Operation is subject to the following two conditions: (1) This device may not cause harmful interference, and (2) this device must accept any interference received, including interference that may cause undesired operation.

WARNING

The connection of a non-shielded equipment interface cable to this equipment will invalidate the FCC Certification or Declaration of this device and may cause interference levels which exceed the limits established by the FCC for this equipment. It is the responsibility of the user to obtain and use a shielded equipment interface cable with this device. If this equipment has more than one interface connector, do not leave cables connected to unused interfaces. Changes or modifications not expressly approved by the manufacturer could void the user's authority to operate the equipment.

For Canadian Users

CAN ICES-3(B)/NMB-3(B)

Parent topic: [Notices](#)

Binding Arbitration and Class Waiver

1. DISPUTES, BINDING INDIVIDUAL ARBITRATION, AND WAIVER OF CLASS ACTIONS AND CLASS ARBITRATIONS

1.1 Disputes. The terms of this Section 1 shall apply to all Disputes between you and Epson. The term "Dispute" is meant to have the broadest meaning permissible under law and includes any dispute, claim, controversy or action between you and Epson arising out of or relating to this Agreement, Epson branded products (hardware and including any related software), or other transaction involving you and Epson, whether in contract, warranty, misrepresentation, fraud, tort, intentional tort, statute, regulation, ordinance, or any other legal or equitable basis. "DISPUTE" DOES NOT INCLUDE IP CLAIMS, or more specifically, a claim or cause of action for (a) trademark infringement or dilution, (b) patent infringement, (c) copyright infringement or misuse, or (d) trade secret misappropriation (an "IP Claim"). You and Epson also agree, notwithstanding Section 1.6, that a court, not an arbitrator, may decide if a claim or cause of action is for an IP Claim.

1.2 Binding Arbitration. You and Epson agree that all Disputes shall be resolved by binding arbitration according to this Agreement. **ARBITRATION MEANS THAT YOU WAIVE YOUR RIGHT TO A JUDGE OR JURY IN A COURT PROCEEDING AND YOUR GROUNDS FOR APPEAL ARE LIMITED.**

Pursuant to this Agreement, binding arbitration shall be administered by JAMS, a nationally recognized arbitration authority, pursuant to its code of procedures then in effect for consumer related disputes, but excluding any rules that permit joinder or class actions in arbitration (for more detail on procedure, see Section 1.6 below). You and Epson understand and agree that (a) the Federal Arbitration Act (9 U.S.C. §1, et seq.) governs the interpretation and enforcement of this Section 1, (b) this Agreement memorializes a transaction in interstate commerce, and (c) this Section 1 shall survive termination of this Agreement.

1.3 Pre-Arbitration Steps and Notice. Before submitting a claim for arbitration, you and Epson agree to try, for sixty (60) days, to resolve any Dispute informally. If Epson and you do not reach an agreement to resolve the Dispute within the sixty (60) days, you or Epson may commence an arbitration. Notice to Epson must be addressed to: Epson America, Inc., ATTN: Legal Department, 3131 Katella Ave., Los Alamitos, CA 90720 (the "Epson Address"). The Dispute Notice to you will be sent to the most recent address Epson has in its records for you. For this reason, it is important to notify us if your address changes by emailing us at EAILEgal@ea.epson.com or writing us at the Epson Address above. Notice of the Dispute shall include the sender's name, address and contact information, the facts giving rise to the Dispute, and the relief requested (the "Dispute Notice"). Following receipt of the Dispute Notice, Epson and you agree to act in good faith to resolve the Dispute before commencing arbitration.

1.4 Small Claims Court. Notwithstanding the foregoing, you may bring an individual action in the small claims court of your state or municipality if the action is within that court's jurisdiction and is pending only in that court.

1.5 WAIVER OF CLASS ACTIONS AND CLASS ARBITRATIONS. YOU AND EPSON AGREE THAT EACH PARTY MAY BRING DISPUTES AGAINST THE OTHER PARTY ONLY IN AN INDIVIDUAL CAPACITY, AND NOT AS A PLAINTIFF OR CLASS MEMBER IN ANY CLASS OR REPRESENTATIVE PROCEEDING, INCLUDING WITHOUT LIMITATION FEDERAL OR STATE CLASS ACTIONS, OR CLASS ARBITRATIONS. CLASS ACTION LAWSUITS, CLASS-WIDE ARBITRATIONS, PRIVATE ATTORNEY-GENERAL ACTIONS, AND ANY OTHER PROCEEDING WHERE SOMEONE ACTS IN A REPRESENTATIVE CAPACITY ARE NOT ALLOWED. ACCORDINGLY, UNDER THE ARBITRATION PROCEDURES OUTLINED IN THIS SECTION, AN ARBITRATOR SHALL NOT COMBINE OR CONSOLIDATE MORE THAN ONE PARTY'S CLAIMS WITHOUT THE WRITTEN CONSENT OF ALL AFFECTED PARTIES TO AN ARBITRATION PROCEEDING.

1.6 Arbitration Procedure. If you or Epson commences arbitration, the arbitration shall be governed by the rules of JAMS that are in effect when the arbitration is filed, excluding any rules that permit arbitration on a class or representative basis (the "JAMS Rules"), available at <http://www.jamsadr.com> or by calling 1-800-352-5267 (U.S. or Canada), or <https://www.jamsadr.com/about/> or by calling +1-949-224-1810 (Latin America), and under the rules set forth in this Agreement. All Disputes shall be resolved by a single neutral arbitrator, and both parties shall have a reasonable opportunity to participate in the selection of the arbitrator. The arbitrator is bound by the terms of this Agreement. The arbitrator, and not any federal, state or local court or agency, shall have exclusive authority to resolve all disputes arising out of or relating to the interpretation, applicability, enforceability or formation of this Agreement, including any claim that all or any part of this Agreement is void or voidable. Notwithstanding this broad delegation of authority to the arbitrator, a court may determine the limited question of whether a claim or cause of action is for an IP Claim, which is excluded from the definition of "Disputes" in Section 1.1 above. The arbitrator shall be empowered to grant whatever relief would be available in a court under law or in equity. The arbitrator may award you the same damages as a court could, and may award declaratory or injunctive relief only in favor of the individual party seeking relief and only to the extent necessary to provide relief warranted by that party's individual claim. In some instances, the costs of arbitration can exceed the costs of litigation and the right to discovery may be more limited in arbitration than in court. The arbitrator's award is binding and may be entered as a judgment in any court of competent jurisdiction.

You may choose to engage in arbitration hearings by telephone. Arbitration hearings not conducted by telephone shall take place in a location reasonably accessible from your primary residence, or in Orange County, California, at your option.

a) Initiation of Arbitration Proceeding. If either you or Epson decides to arbitrate a Dispute, both parties agree to the following procedure:

(i) Write a Demand for Arbitration. The demand must include a description of the Dispute and the amount of damages sought to be recovered. You can find a copy of a Demand for Arbitration at <http://www.jamsadr.com> ("Demand for Arbitration").

(ii) Send three copies of the Demand for Arbitration, plus the appropriate filing fee, to: JAMS, 500 North State College Blvd., Suite 600 Orange, CA 92868, U.S.A.

(iii) Send one copy of the Demand for Arbitration to the other party (same address as the Dispute Notice), or as otherwise agreed by the parties.

b) Hearing Format. During the arbitration, the amount of any settlement offer made shall not be disclosed to the arbitrator until after the arbitrator determines the amount, if any, to which you or Epson is entitled. The discovery or exchange of non-privileged information relevant to the Dispute may be allowed during the arbitration.

c) Arbitration Fees. Epson shall pay, or (if applicable) reimburse you for, all JAMS filings and arbitrator fees for any arbitration commenced (by you or Epson) pursuant to provisions of this Agreement.

d) Award in Your Favor. For Disputes in which you or Epson seeks \$75,000 or less in damages exclusive of attorney's fees and costs, if the arbitrator's decision results in an award to you in an amount greater than Epson's last written offer, if any, to settle the Dispute, Epson will: (i) pay you \$1,000 or the amount of the award, whichever is greater; (ii) pay you twice the amount of your reasonable attorney's fees, if any; and (iii) reimburse you for any expenses (including expert witness fees and costs) that your attorney reasonably accrues for investigating, preparing, and pursuing the Dispute in arbitration. Except as agreed upon by you and Epson in writing, the arbitrator shall determine the amount of fees, costs, and expenses to be paid by Epson pursuant to this Section 1.6d).

e) Attorney's Fees. Epson will not seek its attorney's fees and expenses for any arbitration commenced involving a Dispute under this Agreement. Your right to attorney's fees and expenses under Section 1.6d) above does not limit your rights to attorney's fees and expenses under applicable law; notwithstanding the foregoing, the arbitrator may not award duplicative awards of attorney's fees and expenses.

1.7 Opt-out. You may elect to opt-out (exclude yourself) from the final, binding, individual arbitration procedure and waiver of class and representative proceedings specified in this Agreement by sending a written letter to the Epson Address within thirty (30) days of your assent to this Agreement (including without limitation the purchase, download, installation of the Software or other applicable use of Epson Hardware, products and services) that specifies (i) your name, (ii) your mailing address, and (iii) your request to be excluded from the final, binding individual arbitration procedure and waiver of class and representative proceedings specified in this Section 1. In the event that you opt-out consistent with the procedure set forth above, all other terms shall continue to apply, including the requirement to provide notice prior to litigation.

1.8 Amendments to Section 1. Notwithstanding any provision in this Agreement to the contrary, you and Epson agree that if Epson makes any future amendments to the dispute resolution procedure and class action waiver provisions (other than a change to Epson's address) in this Agreement, Epson will obtain your affirmative assent to the applicable amendment. If you do not affirmatively assent to the applicable amendment, you are agreeing that you will arbitrate any Dispute between the parties in

accordance with the language of this Section 1 (or resolve disputes as provided for in Section 1.7, if you timely elected to opt-out when you first assented to this Agreement).

1.9 Severability. If any provision in this Section 1 is found to be unenforceable, that provision shall be severed with the remainder of this Agreement remaining in full force and effect. **The foregoing shall not apply to the prohibition against class or representative actions as provided in Section 1.5. This means that if Section 1.5 is found to be unenforceable, the entire Section 1 (but only Section 1) shall be null and void.**

Parent topic: [Notices](#)

Trademarks

EPSON® and Quick Corner® are registered trademarks of Seiko Epson Corporation.

PrivateLine® is a registered trademark and SizeWise™ is a trademark of Epson America, Inc.

Windows is a trademark of the Microsoft group of companies.

Mac, macOS, and OS X are trademarks of Apple Inc., registered in the U.S. and other countries.

HDMI and High-Definition Multimedia Interface are the trademarks or registered trademarks of HDMI Licensing LLC.  HIGH DEFINITION MULTIMEDIA INTERFACE

General Notice: Other product names used herein are for identification purposes only and may be trademarks of their respective owners. Epson disclaims any and all rights in those marks.



Parent topic: [Notices](#)

Copyright Notice

All rights reserved. No part of this publication may be reproduced, stored in a retrieval system, or transmitted in any form or by any means, electronic, mechanical, photocopying, recording, or otherwise, without the prior written permission of Seiko Epson Corporation. The information contained herein is designed only for use with this Epson product. Epson is not responsible for any use of this information as applied to other products.

Neither Seiko Epson Corporation nor its affiliates shall be liable to the purchaser of this product or third parties for damages, losses, costs, or expenses incurred by purchaser or third parties as a result of:

accident, misuse, or abuse of this product or unauthorized modifications, repairs, or alterations to this product, or (excluding the U.S.) failure to strictly comply with Seiko Epson Corporation's operating and maintenance instructions.

Seiko Epson Corporation shall not be liable for any damages or problems arising from the use of any options or any consumable products other than those designated as Original Epson Products or Epson Approved Products by Seiko Epson Corporation.

This information is subject to change without notice.

[A Note Concerning Responsible Use of Copyrighted Materials](#)
[Copyright Attribution](#)

Parent topic: [Notices](#)

A Note Concerning Responsible Use of Copyrighted Materials

Epson encourages each user to be responsible and respectful of the copyright laws when using any Epson product. While some countries' laws permit limited copying or reuse of copyrighted material in certain circumstances, those circumstances may not be as broad as some people assume. Contact your legal advisor for any questions regarding copyright law.

Parent topic: [Copyright Notice](#)

Copyright Attribution

© 2025 Epson America, Inc.

4/25

CPD-61119R1

Parent topic: [Copyright Notice](#)